

Owner's Manual

Bumper Pull Utility Trailer



GORILLA
TRAILERS^{LLC}

December 2024



GORILLA TRAILERS^{LLC}



WARNING

This owner's manual contains important safety information and instructions for operating your trailer.

Read this manual thoroughly before loading or towing your trailer.

It is crucial to follow all safety precautions and guidelines to ensure proper usage and avoid accidents.

Gorilla Trailers LLC

264 Hobson St
Smithville, TN 37166

1. Introduction	6
2. Safety	7
2.1 Safety Warning Symbols & Safety Terms	7
2.2 Major Safety Risks	8
2.2.1 Incorrect Trailer & Tow Vehicle Sizing	8
2.2.2 Driving at Unsafe Speeds	9
2.2.3 Modifying Driving Habits for Trailer Towing	9
2.2.4 Unsafe Trailer-to-Hitch Connection	10
2.2.5 Proper Attachment of Safety Chains	12
2.2.6 Ensuring Secure Breakaway Brake Connections	12
2.2.7 Proper Trailer-to-Hitch Matching	13
2.2.8 Inspecting Tires, Wheels & Lug Nuts.....	13
2.2.9 Improper Loading	16
2.2.10 Unbalanced Load Distribution	17
2.2.11 Unsecured Load Movement	18
2.2.12 Non-compliant Cargo	19
2.2.13 Non-Operational Brakes or Lights.....	19
2.2.14 Trailer Modifications	21
2.2.15 Trailer Safety Concerns	21
2.2.16 Trailer Towing Guide	22
2.2.17 Safe Trailer Towing Guidelines	22
2.2.18 Safety Warning Labels on Your Gorilla Trailer.....	26
2.2.19 Report Safety Defects	29
3. Tire Safety Information	30
3.1 Important Trailer Tire Information	31
3.2 Guidelines for Assessing Trailer Load Limits	33
3.2.1 Trailers 10,000 Pounds GVWR or Less	34
3.2.2 Trailers Over 10,000 Pounds GVWR	35
3.3 Guidelines for Assessing Tow Vehicle Load Limits.....	35
3.4 Comprehensive Tire Terminology Guide	36
3.5 Tire Safety - Rides on It	43
3.5.1 Tire Maintenance	45
3.5.2 Locating Vehicle Tire Pressure & Load Limits	45
3.5.3 Understanding Tire Pressure & Load Limits	46
3.5.4 Safety First - Tire Maintenance	46
3.5.5 Maintaining Optimal Tire Pressure	47
3.5.6 Tire Size	48
3.5.7 Tire Tread	48
3.5.8 Tire Balance & Wheel Alignment	48
3.5.9 Tire Repair	49



3.5.10 Tire Fundamentals	49
3.5.10.1 Passenger Vehicle Tire Terminology.....	50
3.5.10.2 UTQGS Terminology	52
3.5.10.3 Light Truck Terminology	53
3.5.10.4 Tire Safety	54
4. Connecting to Tow Vehicle	55
4.1 Tow Vehicle and Hitch	55
4.1.1 Trailer Certification / VIN Tag	55
4.1.2 Outfitting a Tow Vehicle	57
4.2 Attaching & Detaching the Trailer	57
4.3 Connecting Trailer to Tow Vehicle	59
4.3.1 Ball Hitch Coupler	59
4.3.1.1 Pre-Coupling Preparation Checklist	60
4.3.1.2 Steps to Prepare Coupler & Hitch	61
4.3.1.3 Hitch Trailer to Tow Vehicle	62
4.3.2 Ring and Pintle Coupler	63
4.3.2.1 Before Coupling Trailer to Tow Vehicle	63
4.3.2.2 Prepare Ring and Pintle	65
4.3.2.3 Hitch Trailer to Tow Vehicle	66
4.3.3 Connect Safety Chains	67
4.3.4 Proper Connection of Trailer Lights	68
4.3.5 Attach Breakaway Brake Lanyard (If Equipped)	69
4.3.5.1 Test Your Electric Brakes	69
4.3.5.2 Test Your Electric Breakaway Brakes	70
4.3.5.3 Test Surge Brakes	72
4.3.5.4 Test Surge Breakaway System	74
4.4 Uncouple Trailer	74
4.5 Tongue Weight	75
4.5.1 How to Check Tongue Weight	76
4.6 How to Adjust Hitch Height (If Equipped)	78
5. Safe Trailer Loading Guidelines	80
5.1 Loading Trailer	82
5.1.1 Preparing Trailer for Loading	82
5.1.2 Loading a Rigid Deck Trailer	82
5.1.3 Loading a Tilt Deck Trailer	84
5.1.3.1 Manual Tilt Trailer	84
5.1.3.2 Hydraulic Tilt Trailer	85
5.2 Unloading Trailer	86
5.2.1 Unload Manual Tilt Trailer	86
5.2.2 Unload Hydraulic Tilt Trailer	88
5.3 Hydraulic Components	89
5.4 Securing Cargo	89

6. Pre-Tow Checklist	90
6.1 Pre-Tow Checklist	90
6.2 Routine Towing Checks	90
7. Breaking In a New Trailer	91
7.1 Retighten Lugs at Mile Markers 10, 25 & 50	91
7.2 Adjust Brakes at First 200 Miles	91
7.3 Trailer Brake Synchronization	92
8. Accessories	92
8.1 Accessory Battery	93
9. Inspection, Service, & Maintenance	94
9.1 Inspection, Service & Maintenance Summary Charts	94
9.2 Inspection & Service Instructions	99
9.2.1 Washing Your Trailer is Important Too	100
9.2.1.1 Fastners & Frame Members	100
9.2.1.2 Welds	100
9.2.2 Electric Trailer Brakes	101
9.2.2.1 Brake Discs, Shoes & Drums	101
9.2.2.2 Manually Adjusting Brake Shoes	102
9.2.2.3 Types of Electric Brakes	103
9.2.2.4 Tow Vehicle Operated Electric Brakes	105
9.2.2.5 Electric Brake Magnets	105
9.2.3 Hydraulic Trailer Brakes (If Equipped).....	105
9.2.3.1 Surge Brake Master Cylinder	105
9.2.3.2 Hydraulic Surge Brake	106
9.2.3.3 Master Cylinder Bleeding	107
9.2.2.4 Tow Vehicle Operated Electric Brakes	109
9.2.2.5 Electric Brake Magnets	109
9.2.3 Trailer Brakes – Surge (If Equipped)	109
9.2.3.1 Surge Brake Master Cylinder	109
9.2.3.2 Hydraulic Surge Brake	110
9.2.4 Trailer Connection to Tow Vehicle	113
9.2.4.1 Coupler & Ball	113
9.2.4.2 Ring and Pintle	114
9.2.5 Landing Leg or Jack	115
9.2.6 Lights & Signals	115
9.2.7 Wheel Rims	115
9.2.8 Wheel Bearings	115
9.2.9 Tires	118
9.2.10 Lubrication	118
9.2.11 Hydraulic Reservoir	118
9.2.12 Lug Nuts	118
10. Warranty Policy	120

Congratulations on your new trailer purchase!

At Gorilla Trailers LLC, we sincerely thank you for choosing us to meet your trailer needs. We're confident you'll be completely satisfied with your purchase, as we deliver Gorilla-strong quality at an affordable price.

For your safety, please be sure to read and fully understand this manual before operating your trailer to ensure your safety. If you have any questions about the information provided, consult your dealer for clarification.

When contacting your dealer about your trailer, have the VIN number readily available. The VIN is typically located on the front left side of the trailer.

For easy reference, write your VIN number in the space below:

This manual covers the basic trailer. It is essential to read, understand, and follow the instructions provided by the trailer manufacturer, tow vehicle manufacturer, and trailer hitch manufacturer. Always store all manuals provided with your trailer in a safe and accessible location.

Inserts containing information on axles and tire warranties are included with this manual. Be sure to keep these inserts for future reference.

2. Safety

2.1 Safety Warning Symbols & Safety Terms

An Owner's Manual that provides general trailer information cannot address all the specific details required for the proper pairing of every trailer, tow vehicle, and hitch. It is important to read, understand, and follow the instructions provided by the tow vehicle and trailer hitch manufacturers, as well as the guidelines in this manual.

Our trailers are constructed using components from various manufacturers, some of which may include separate instruction manuals. If this manual directs you to consult another manual and you do not have it, please contact your dealer for assistance.

The safety information in this manual is identified by the safety alert symbol:



This symbol indicates:

ATTENTION! BE ALERT! YOUR SAFETY IS AT RISK!

The level of risk is identified by the following signal words:

 DANGER
DANGER - Indicates a hazardous situation, which, if not avoided, WILL result in death or serious injury.
 WARNING
WARNING - Indicates a hazardous situation, which, if not avoided, could result in death or serious injury.
 CAUTION
CAUTION - Indicates a hazardous situation, which, if not avoided, could result in minor or moderate injury.
NOTICE
NOTICE - Indicates a situation that could result in damage to the equipment or other property.

2.2 Major Safety Risks

Losing control of the trailer or the trailer/tow vehicle combination can lead to serious injury or death. Common causes of loss of control include:

- Driving too fast for the conditions.
- Improper braking or steering during trailer sway.
- Failing to properly secure the trailer to the hitch.
- Overloading the trailer or improper weight distribution.
- Driving with incorrect tire pressure.
- Failing to keep lug nuts properly tightened.
- Mismatching the size of the trailer and tow vehicle.
- Not adjusting driving behavior when towing a trailer.

2.2.1 Incorrect Trailer and Tow Vehicle Sizing

Trailers that exceed the towing capacity of the tow vehicle can cause stability issues, which may result in serious injury or death. The additional strain placed on the engine and drivetrain can also lead to significant mechanical failures and maintenance complications.

It is essential not to surpass the maximum towing capacity of your tow vehicles. The maximum *Gross Trailer Weight (GTW)* and *Gross Combined Weight Rating (GCWR)* can be found in the tow vehicle's *Owner's Manual*.

 DANGER
Use of an under-rated hitch, ball or tow vehicle can result in loss of control leading to death or serious injury.
Make certain your hitch and tow vehicle are rated for your trailer.

2.2.2 Driving at Unsafe Speeds

Under optimal road conditions, the recommended maximum speed for towing a trailer is 55 mph. Exceeding this speed can lead to trailer swaying, increasing the risk of losing control. Additionally, excessive speed can cause the tires to overheat, raising the likelihood of a blowout.

 WARNING
Driving too fast for conditions can result in loss of control and cause death or serious injury.
Adjust speed down when towing trailer.

2.2.3 Modifying Driving Habits for Trailer Towing

When towing a trailer, you will experience reduced acceleration, longer stopping distances, and a wider turning radius.

The presence of the trailer alters the handling characteristics of the tow vehicle, making it more responsive to steering inputs and more susceptible to being affected by wind or large vehicles passing by. Additionally, due to slower acceleration and increased vehicle length, you will need more distance to pass other vehicles.

With this in mind:

- Regularly check your rearview mirrors to monitor the trailer and surrounding traffic.
- Stay alert for slippery road conditions. Towing a trailer makes you more susceptible to the effects of slippery surfaces compared to towing without one.
- Be mindful of trailer height, particularly when approaching bridges, roofed areas, or trees.
- Anticipate trailer sway, which can be caused by excessive steering, wind gusts, uneven road edges, or the pressure waves generated by passing trucks and buses.
- If you encounter trailer sway, take your foot off the accelerator and make minimal steering adjustments to stay on course. Avoid attempting to steer out of the sway, as this will likely worsen the situation. Do not apply the tow vehicle brakes to correct trailer sway. Applying the trailer brakes alone can help straighten the combination, especially when going downhill.
- When driving down steep or long grades, use a lower gear and rely on the engine and transmission for braking. Avoid riding the brakes, as this can cause them to overheat and lose effectiveness.

2.2.4 Unsafe Trailer-to-Hitch Connection

It is crucial that the trailer is securely coupled to the hitch, and that the safety chains and emergency breakaway brake lanyard are properly attached. Failure to ensure these connections could result in death or serious injury to you and others.



WARNING

Proper selection and condition of the coupler and hitch are essential to safely towing a trailer.

A loss of coupling may result in death or serious injury.

Hitch size must match coupler size.

Be sure hitch load rating is equal to or greater than load rating of the coupler.

Be sure hitch components are tight before coupling trailer to tow vehicle.

Observe hitch for wear, corrosion and cracks before coupling. Replace worn, corroded or cracked hitch components before coupling trailer to tow vehicle.



WARNING

An improperly coupled trailer can result in death or serious injury. Do not move the trailer until:

- Coupler is secured and locked to hitch.
- Safety chains are secured to tow vehicle.
- Trailer jack(s) are fully retracted.
- Trailer brakes are checked.
- Tires and wheels are checked.
- Breakaway switch is connected to tow vehicle;
- The trailer lights are connected and checked.
- Load is secured to trailer.

2.2.5 Proper Attachment of Safety Chains

Safety chains are included to help maintain control of the trailer in the event it becomes detached from the hitch.

 WARNING
<p>Improper rigging of the safety chains can result in loss of control of the trailer and tow vehicle, leading to death or serious injury, if the trailer uncouples from the tow vehicle.</p>
<p>Cross chains underneath hitch and coupler with enough slack to permit turning and to hold tongue up, if the trailer comes loose.</p>
<p>Fasten chains to frame of tow vehicle.</p>
<p>Do not fasten chains to any part of the hitch unless the hitch has holes or loops specifically for that purpose.</p>

2.2.6 Ensuring Secure Breakaway Brake Connections

If your trailer is equipped with brakes, it will also feature a breakaway brake system designed to activate the trailer's brakes if it becomes detached from the hitch. Additional instructions for the breakaway brake system may be provided if your trailer includes this feature. To ensure effectiveness, the breakaway brake system, including its battery, must be properly maintained and connected.



WARNING

An ineffective or inoperative breakaway brake system can result in a runaway trailer, leading to death or serious injury if the coupler or hitch fails.

Breakaway lanyard must be connected to the tow vehicle, NOT to any part of the hitch.

Before towing trailer, test the function of the breakaway brake system. If the breakaway brake system is not working, do not tow the trailer. Have it serviced or repaired.

2.2.7 Proper Trailer-to-Hitch Matching



DANGER

Be sure hitch and tow vehicle are rated for the Gross Vehicle Weight Rating (GVWR) of your trailer.

Use of a hitch with a load rating less than the load rating of the trailer can result in loss of control and may lead to death or serious injury.

Use of a tow vehicle with a towing capacity less than the load rating of the trailer can result in loss of control, and may lead to death or serious injury.

2.2.8 Inspecting Tires, Wheels and Lug Nuts

Before setting out on any trip, it is essential to inspect all trailer tires to ensure they are in optimal condition for safe towing. Look for any visible signs of wear or damage, such as bald spots, bulges, cuts, cracks, or exposed cords, as these can compromise the tire's integrity. Replace any tire that shows these issues to

prevent potential failures while on the road.

If you notice uneven tread wear, it is crucial to have the trailer assessed by a professional service center. Uneven wear may signal underlying problems, such as tire imbalance, axle misalignment, or improper inflation. Addressing these issues promptly will ensure smoother towing and longer tire life.

Tires with insufficient tread depth significantly reduce traction, especially on wet or slippery roads, making it harder to maintain control of your trailer. This situation can pose serious risks, potentially leading to accidents or severe injuries. Always check tread depth to ensure your tires provide reliable grip in all conditions.

Maintaining proper tire pressure is another critical factor in safe towing. Incorrect pressure not only accelerates tire wear but also affects trailer stability, increasing the likelihood of a blowout or loss of control. Make it a habit to check tire pressure before each use to ensure your trailer is ready for the road.

You can find the recommended tire pressure on the Certification/VIN label, usually located on the front left side of the trailer. For accurate readings, check tire pressure when the tires are cold. After driving just one mile at speeds of 40 mph or higher, allow at least three hours for the tires to cool before taking a measurement. Taking these precautions will help you avoid unnecessary risks and ensure a safer, more enjoyable towing experience.



WARNING

Inflate tires to pressure stated on the Certification / VIN label.

Improper tire pressure may cause unstable trailer. Blowout and loss of control may occur. Death or serious injury can result.

Make sure of proper tire pressure before towing trailer.

Properly tightening the wheel nuts or bolts is essential for ensuring the wheels remain securely attached to the hub. Always check their tightness before each use to ensure safe towing.



WARNING

Metal creep between the wheel rim and wheel nuts or bolts may cause rim to loosen.

Death or injury can occur if wheel comes off.

Tighten lug nuts or bolts before each tow.

The correct torque values and tightening sequence for wheel nuts or bolts are provided in the Inspection, Service, and Maintenance section of this manual. Be sure to use a torque wrench and follow the crisscross star pattern when tightening the lug nuts. Improper tightening will void the axle warranty.

After initial assembly or when wheels are remounted, wheel nuts or bolts may loosen. It is crucial to check the tightness of the nuts at 10, 25, and 50 miles of driving, as well as before each subsequent tow.

Neglecting this check can cause the wheels to detach from the trailer, leading to a crash and potentially resulting in serious injury or death.



WARNING

Wheel nuts or bolts are prone to loosen after being first assembled. Death or serious injury can result.

Check wheel nuts or bolts for tightness on a new trailer, and after re-mounting a wheel at 10, 25 and 50 miles.



WARNING

Inadequate wheel nut or bolt torque can cause a wheel to separate from the trailer, leading to death or serious injury.

Verify wheel nuts or bolts are tight before each tow.

2.2.9 Improper Loading

The total weight of the trailer, including its empty weight and the load it carries, must not exceed the Gross Vehicle Weight Rating (GVWR). If you are unsure of the combined weight of the trailer and its cargo, weigh the fully loaded trailer at a commercial scale.

Additionally, the load must be distributed so that no axle exceeds its Gross Axle Weight Rating (GAWR). These ratings are listed on the Certification/VIN label, typically located on the front left side of the trailer.

If your trailer has a Tire & Loading Information Placard near the Certification/VIN label, the stated cargo capacity is an estimate. For accurate weight management, always rely on the GVWR and GAWR specified on the Certification/VIN label.



WARNING

An overloaded trailer can result in failure or loss of control of the trailer, leading to death or serious injury.

Never load a trailer so that the weight on any tire exceeds its rating.

Never exceed the trailer Gross Vehicle Weight Rating (GVWR) or axle Gross Axle Weight Rating (GAWR).

2.2.10 Unbalanced Load Distribution

Improper weight distribution between the front and rear of a trailer can cause instability or poor handling of the tow vehicle. A trailer becomes unstable when the tongue weight is too low, while excessive tongue weight compromises the tow vehicle's stability.

For detailed guidelines, refer to the "Loading and Unloading" section.

The table below outlines the recommended tongue weight as a percentage of the trailer's total loaded weight (*Gross Trailer Weight* or *GTW*). For instance, a fully loaded trailer weighing 6,000 pounds should have 10-15% of its weight (600-900 pounds) on the hitch.

Tongue Weight as a Percentage of Loaded Trailer Weight	
Type of Hitch	Percentage
Ball Hitch or Ring & Pintle	10-15% for large trailers 6-10% for small trailers

The provided numbers are examples only and should be customized for your specific trailer. For exact tongue weight percentages, consult the trailer's manufacturer.

Important Loading Considerations:

Avoid Axle Overloading:

After loading, verify that no axle is carrying more weight than its limit.

Maintain Left/Right Balance:

Uneven weight distribution can cause tire, wheel, axle, or structural failure. Ensure the load is evenly spread across both sides.

Low Center of Gravity:

Stability during towing is enhanced when the load's center of gravity is kept as low as possible.

Proper loading ensures safe and stable trailer operation.

 WARNING	
<p>Improper tongue weight (load distribution) can result in loss of control of the trailer, leading to death or serious injury.</p>	
<p>Make certain that tongue weight is within the allowable range.</p>	
<p>Be sure to:</p>	
<ul style="list-style-type: none">• Distribute the load evenly, right and left.• Keep the center of gravity low.• Distribute the load front-to-rear to provide proper tongue weight (see chart).	

2.2.11 Unsecured Load Movement

Trailers frequently face uneven roads, and unsecured cargo can shift, risking damage to the load and trailer while compromising stability, which may lead to unsafe driving conditions.



WARNING

A shifting load can result in failure, or to loss of control of the trailer, and can lead to death or serious injury.

You must tie down all loads with proper sized fasteners, chains, straps, etc. to prevent the load from shifting while towing.

2.2.12 Non-Compliant Cargo

Trailers are often designed to carry specific types of cargo. If your trailer is specialized, it should only be used for its intended purpose. Never use a trailer to transport prohibited items, such as people, hazardous materials, or flammable substances.



WARNING

Do not transport people inside or on your trailer. Besides putting their lives at risk, the transport of people in or on a trailer is illegal.



WARNING

Do not transport flammable, explosive, poisonous or other dangerous materials in your trailer.

The exception is fuel in the tank of a vehicle or equipment being hauled.

2.2.13 Non-Operational Brakes or Lights

If your trailer is equipped with electric brakes, the tow vehicle must have an electric brake controller to supply power to them.

Before towing, test the brake controller by attempting to pull the trailer while manually operating the controller. Perform this test at a speed of less than 5 mph to ensure the trailer brakes engage properly.

If your trailer is equipped with hydraulic surge brakes, test the system by pulling the emergency breakaway brake lanyard to ensure the surge mechanism is functioning correctly.

Additionally, confirm that all trailer lights and electric brakes are fully functional before starting your journey. These systems are typically connected to the tow vehicle through a multi-pin electrical connector, so ensure the connection is secure and in good working condition.

 WARNING
<p>Improper electrical connection between the tow vehicle and the trailer will result in inoperable lights and electric brakes, and can lead to collision.</p> <p>Before each tow:</p> <ul style="list-style-type: none">• Check that the electric brakes work by operating the brake controller inside the tow vehicle.• Check that all lights and turn signals work.

You must ensure your tow vehicle is equipped with mirrors that allow for safe observation of approaching traffic. Standard mirrors often do not provide adequate visibility to monitor the sides and rear of a towed trailer.

2.2.14 Trailer Modifications

Modifying the trailer structure or making alterations can compromise its safety and void any warranty. Before making any changes to the trailer, consult your dealer or the manufacturer to discuss the proposed modification.

2.2.15 Trailer Towing Guide

Towing a trailer requires significant adjustments compared to driving without one. Towing affects acceleration, maneuverability, and braking, requiring greater time to accelerate, more space to turn and pass, and increased stopping distances.

Key Tips for Towing:

- **Practice and Adjustment:**

Spend time familiarizing yourself with the feel and maneuverability of the tow vehicle and trailer. Start in a low-traffic area to practice and build confidence.

- **Inspection and Preparation:**

Before towing, complete all inspections, adjust mirrors for clear visibility of the trailer and rear area, and follow loading and coupling instructions.

- **Driving Adjustments:**

Begin at low speeds (5 mph) and practice turning, observing the trailer's path in the mirrors. Use extra room for turns, as the trailer requires more space to follow.

- **Braking Tests:**

Gradually stop from low speeds (10 mph) and experiment with different brake combinations. Ensure trailer brakes engage slightly before the tow vehicle

brakes for optimal control.

• **Backing Up:**

Backing up takes practice. Before reversing, check behind the trailer for obstacles. Use the "bottom of the steering wheel" method for easier directional control:

- Move hands counterclockwise (right) to steer the trailer's rear to the right.
- Move hands clockwise (left) to steer the trailer's rear to the left.

Important Notes:

- Avoid sharp turns while reversing to prevent the trailer from colliding with the tow vehicle.
- To straighten the rig, either pull forward or turn the wheel in the opposite direction.

Practicing these skills ensures safer and more confident towing.

2.2.16 Safe Trailer Towing Guidelines

Detailed Safe Trailer Towing Guidelines

Pre-Towing Checks:

- Inspect the **coupling, safety chains, brakes, tires, wheels, and lights** for functionality.
- Ensure **lug nuts or bolts** are tight.
- Verify **load tie-downs** are secure to prevent shifting.

First 50 Miles:

- Recheck the **coupler tightness** after towing 50 miles.

Brake Adjustments:

- Adjust the brake controller to activate the **trailer brakes before the tow vehicle brakes** for better control. Follow the manufacturer's instructions for proper adjustment.

Driving Practices:

- Use **mirrors** to monitor traffic and ensure safe lane changes.
- Signal well in advance when changing lanes or turning.
- Allow for increased stopping distance to account for the trailer.
- Utilize **lower gears** when ascending or descending grades.
- Avoid riding brakes on downhill slopes to prevent overheating. Use lower gears to maintain control.

Trailer Sway Management:

- Never apply tow vehicle brakes to correct sway; instead, **lightly apply trailer brakes** using the hand controller.

Regular Stops:

- Stop approximately once an hour to confirm:
 - Coupler is secure and locked.
 - Electrical connections are intact.
 - Safety chains and breakaway lanyard have appropriate slack.

- Tires are properly inflated.
- Cargo remains secure.

Speed and Maneuvering:

- Reduce speed for bumps.
- Avoid braking in curves unless unavoidable; slow down beforehand.
- Keep speed below **55 mph** to minimize sway risks.

Passing Considerations:

Allow **four times the usual distance** when passing with a trailer compared to without one.

Practicing these guidelines ensures safety and control while towing a trailer.

Condensed Version:

Check coupling, safety chains, brakes, tires, and lights before towing. Tighten lug nuts and secure cargo. Recheck coupler tightness after 50 miles. Adjust brake controller to engage trailer brakes first. Use mirrors, signal early, and maintain plenty of stopping space. Use lower gears for hills and avoid riding brakes. Correct sway by lightly applying trailer brakes. Stop hourly to check coupler, electrical connections, chains, lanyards, tires, and cargo. Drive under 55 mph, slow down for bumps, and avoid braking in curves. Allow four times the passing distance compared to without a trailer.



WARNING

A soft and/or uneven surface may cause tow vehicle and trailer to tip over when dump body is raised.

Raise dump body ONLY if tow vehicle and trailer are both on a firm and level surface.



WARNING

Electrocution hazard.

Dump body coming near or contacting power lines can cause electrocution.

Electrocution can occur without contact.

Verify there are no overhead power lines over or near the trailer before raising dump body.



WARNING

An overloaded trailer or improperly distributed load can result in death or serious injury.

An overloaded trailer can cause hydraulic system to malfunction, resulting in dump body falling.

A load that is improperly distributed in the trailer can result in the trailer tipping over when the dump body is raised.



DANGER

NEVER alter or substitute any hydraulic system component. Death or serious injury may result.

An altered or component substituted hydraulic system may malfunction, resulting in the dump body falling without warning.

NEVER alter or substitute any hydraulic system component.

2.2.18 Safety Warning Labels on Your Gorilla Trailer

The safety labels on your trailer may vary depending on its configuration, so it may not include all the labels shown.

⚠ WARNING ⚠

ALWAYS use safety chains. Chains hold trailer if connection fails.
Ensure the following are properly done:

1. **CROSS** chains underneath coupler.
2. **ALLOW** slack for trailer to turn.
3. **ATTACH** chain hooks securely to tow vehicle frame.
4. **CHECK** ball size matches coupler size before use.
5. **CONNECT** wiring harness before use to check light functionality.
6. **CHECK** that lug nuts on wheels are tight before every use.

For more information about this trailer visit www.gorillatrailer.com/terms-conditions-warranty

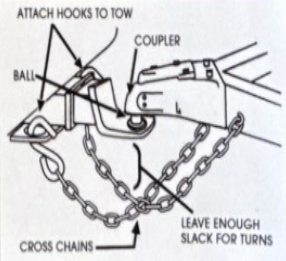

The diagram illustrates the correct way to attach safety chains. It shows a tow vehicle's hitch with a ball and a trailer's coupler. Two chains are attached to the tow vehicle's frame and crossed underneath the coupler. Labels include: 'ATTACH HOOKS TO TOW' pointing to the chain links on the vehicle frame; 'BALL' pointing to the hitch ball; 'COUPLER' pointing to the trailer's hitch; 'CROSS CHAINS' pointing to the crossed chains; and 'LEAVE ENOUGH SLACK FOR TURNS' pointing to the slack in the chains.

DANGER

**PINCH
POINTS**

**WATCH YOUR
HANDS**

**WEIGHT CAPACITY
OF GATE: 1,200 LB
ROLLING WEIGHT**



For more information about this trailer visit www.gorillatrailer.com/terms-conditions-warranty

The label features a white hand icon with a red square containing a white downward-pointing arrow, indicating a pinch point where the hand could be caught.

⚠ WARNING

SERIOUS INJURY, DEATH AND/OR PROPERTY DAMAGE CAN RESULT FROM MISUSE OF THIS VEHICLE

DO NOT EXCEED MANUFACTURER'S RATINGS OR LOADING RECOMMENDATIONS

FOR YOUR SAFETY, FAMILIARIZE YOURSELF WITH THE INSTRUCTIONS AND CAUTIONS LISTED TO THE RIGHT

⚠ CAUTION

BEFORE TOWING THIS TRAILER, CHECK TO MAKE SURE:

WHEEL LUG NUTS ARE PROPERLY TIGHTENED
TIRES ARE INFLATED TO PRESSURE INDICATED ON TIRES. CHECK TIRE PRESSURE WHEN TIRE IS COLD.
REPLACE WHEEL BEARINGS ONCE A YEAR, PREFERABLY IN THE FALL BEFORE STORING TRAILER

JACK IS RETRACTED
LOAD IS WITHIN TRAILER CAPACITY AND DISTRIBUTED PROPERLY TO MAINTAIN PROPER TONGUE WEIGHT. USE CAUTION WHEN LOADING ON WET SURFACE

DRIVE EQUIPMENT ONTO TRAILER SLOWLY
HIGH SPEED LOADING CAN RESULT IN INJURY OR DEATH

MAKE SURE ALL RAMPS, PINS, GATES & LATCHES ARE SECURE AND LOAD IS SECURED TO TRAILER FRONT AND REAR. USE EXTRA ROPE AS A SAFETY MEASURE

⚠ DANGER

NEVER LOAD OR UNLOAD TRAILER NOT PROPERLY COUPLED TO THE TOWING VEHICLE

MAKE SURE!

COUPLER HITCH AND TRAILER BALL ARE THE SAME SIZE, AND COUPLER IS PROPERLY LATCHED

SAFETY CHAINS ARE CROSSED UNDER TONGUE AND PROPERLY ATTACHED TO TOWING VEHICLE

TRAILER BRAKES ARE PROPERLY ATTACHED AND BREAK AWAY KIT IS ATTACHED TO TOWING VEHICLE. HOOK UP BREAK-AWAY CHAIN WITH SLACK TO PERMIT CORNERING

ALL TRAILER LIGHTS ARE WORKING PROPERLY UNDER CARRIAGE BOLTS, NUTS, AND EQUALIZERS ARE TIGHT AND NOT WORN

⚠ NOTICE

YOU ARE REQUIRED TO COMPLY WITH LOCAL AND STATE REQUIREMENTS REGARDING BRAKES, LICENSING, AND ANY ADDITIONAL EQUIPMENT THAT MIGHT BE NECESSARY

CONTACT YOUR STATE MOTOR DEPARTMENT FOR MORE INFORMATION

For more information about this trailer visit www.gorillatrailer.com/terms-conditions-warranty



WARNING

To protect you and others against death or serious injury, all of the labels shown must be on the trailer and must be legible.

If any of these labels are missing or cannot be read, contact your dealer for replacement labels.

2.2.19 Reporting Safety Defects

If you suspect that your vehicle has a defect capable of causing a crash, injury, or death, promptly report it to the National Highway Traffic Safety Administration (NHTSA) and notify:

Gorilla Trailers LLC
264 Hobson St,
Smithville, TN 37166

If NHTSA receives similar complaints, it may initiate an investigation. If a safety defect is identified within a group of vehicles, NHTSA may mandate a recall and initiate a remedy campaign. However, NHTSA does not mediate individual disputes between you, your dealer, or

Gorilla Trailers LLC
264 Hobson St,
Smithville, TN 37166

To reach NHTSA, you can call the Vehicle Safety Hotline at 1-888-327-4236 (TTY: 1-800-424-9153), visit their website at www.safercar.gov, or send mail to:

Administrator, NHTSA
1200 New Jersey Avenue SE
Washington, DC 20590

Additional information about motor vehicle safety can be found at <http://www.safercar.gov>.

3. Tire Safety Information

This section of the User's Manual includes tire safety information in compliance with the requirements of 49 CFR 575.6.

Section 3.1 contains "Important Trailer Tire Information".

Section 3.2 contains "Guidelines for Assessing Trailer Load Limits"

Section 3.3 contains "Guidelines for Assessing Tow Vehicle Load Limits"

Section 3.4 contains "Comprehensive Tire Terminology Guide", includes a glossary of tire terminology, defining terms such as "cold inflation pressure," "maximum inflation pressure," "recommended inflation pressure," and other non-technical terms to help clarify tire safety and maintenance concepts.

Section 3.5 contains "Tire Safety - Rides on It", includes information from the NHTSA brochure titled "Tire Safety - Everything Rides on It."

This brochure, along with the preceding sections, covers the following topics:

- Tire labeling, including an explanation of each tire marking and details about the DOT Tire Identification Number (TIN).
- Recommended tire inflation pressure, covering:

A. Cold inflation pressure.

B. Vehicle placard and its location on the vehicle.

C. Safety risks associated with under-inflation, including

tire failure.

D. How to measure and adjust tire pressure for proper inflation.

- Tire care, including maintenance tips and safety practices.
- Vehicle load limits, including:

A. How to locate and understand load limit information, total load capacity, and cargo capacity.

B. Calculating total and cargo capacities with varying seating configurations, including examples showing how cargo capacity decreases as the number and size of occupants increase (also discussed in Section 3).

C. Determining the compatibility of tire and vehicle load capacities.

D. The safety consequences of overloading, affecting handling and braking.

3.1 Important Trailer Tire Information

Even if trailer tires still have plenty of tread, they can become worn out over time due to the heavy load they bear, even when the trailer isn't in use. In fact, it's often better for the tires to be in motion than idle. Rolling tires naturally release lubricants that help preserve the rubber and prevent flat spots from forming, contributing to a longer tire life.

Improper inflation is the leading cause of tire failure, making regular checks essential. It's important to check the cold inflation pressure at least weekly. "Cold" refers to the tires being at the same temperature as the surrounding air, typically after the vehicle has been parked for several hours. Always follow the manufacturer's recommended cold inflation pressure found on the Federal Certification Label or Tire Placard,

especially when the trailer is loaded to its Gross Vehicle Weight Rating (GVWR). This ensures the tires are properly inflated and capable of handling the weight.

Under-inflated tires or those loaded beyond the GVWR can significantly impact the tire's load-carrying capacity. Over-inflation, on the other hand, can affect vehicle handling and towing stability. Tires naturally lose 1-3 PSI (pounds per square inch) per month due to air molecules migrating through the rubber. Even small drops in pressure can lead to overloads, causing excessive heat buildup and potential damage to the tires. Therefore, keeping the tires properly inflated is crucial for their performance and longevity.

High-speed towing, particularly in hot weather, can accelerate tire wear. As the tires heat up, their internal structure weakens, which compromises their strength and safety. For this reason, it's advised to maintain moderate speeds, especially when towing heavy loads, to preserve the tires' integrity and ensure safe driving. While the average lifespan of a trailer tire is around five years with proper use, it's a good idea to replace them after three years, even if the tread looks fine. After five years, most experts recommend replacing the tires, even if they haven't been used much, due to the natural degradation of the rubber. For the best assessment, have a tire professional inspect the tires to determine if replacement is necessary.

If storing the trailer for a long period, make sure the tires are fully inflated to the recommended pressure. Store the trailer in a cool, dry area, like a garage, to protect the tires from harsh environmental conditions. Using tire covers can also shield the tires from the damaging effects of UV rays and sun exposure, further

extending their life and ensuring they're in good condition when you need them again.

3.2 Guidelines for Assessing Trailer Load Limits

Trailer Limits

Determining a trailer's load limits involves more than just understanding the tire capacities. Each trailer has a Federal Certification / VIN label located on the left (road) side, typically on the forward half of the unit. This label provides essential information, including the trailer's Gross Vehicle Weight Rating (GVWR), which is the maximum weight the fully loaded trailer can safely carry. Additionally, the label includes the Gross Axle Weight Rating (GAWR), which indicates the maximum weight each axle can support. If the trailer has multiple axles, the GAWR for each will be specified.

For trailers with a GVWR of 10,000 pounds or less, a vehicle placard is also located in the same spot as the certification label. This placard contains tire and loading information, as well as a statement indicating the maximum cargo capacity. The cargo should never exceed the maximum weight specified on the placard, which is given as a single number. Always remember that the total weight of the trailer must not surpass its stated GVWR.

When loading the trailer, ensure the cargo is evenly distributed to prevent overloading in any direction. Heavy items should be placed low and close to the axles to maintain balance. Overloading one side of the trailer could damage the tires. To determine the actual weight of your trailer, consider using a public scale, and consult your dealer for advice on the proper

weighing methods. This will help you capture the various weights, such as the empty weight, axle weight, wheel weight, and total weight.

Excessive loads or underinflated tires can cause the tires to overload and flex abnormally, generating excessive heat. This heat buildup is a leading cause of tire failure. Maintaining proper tire inflation is crucial, as the air pressure supports the tire's load. You can find the recommended air pressure on the Certification/VIN label or the Tire Placard. Never exceed the maximum cold inflation pressure indicated on the tire itself. Proper tire inflation helps prevent overheating and enhances the safety and longevity of your trailer tires.

3.2.1 Trailers 10,000 Pounds GVWR or Less

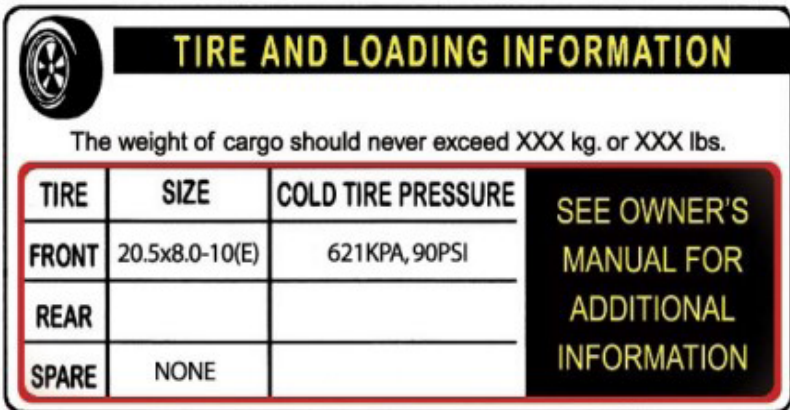

The weight of cargo should never exceed XXX kg. or XXX lbs.

TIRE	SIZE	COLD TIRE PRESSURE
FRONT	20.5x8.0-10(E)	621KPA, 90PSI
REAR		
SPARE	NONE	

SEE OWNER'S MANUAL FOR ADDITIONAL INFORMATION

1. Find the statement on your vehicle's placard that reads, "The weight of cargo should never exceed XXX kg or XXX lbs."
2. This number represents the available cargo and luggage load capacity for your trailer.
3. Calculate the total weight of the cargo and luggage you plan to load onto the vehicle. Ensure that the combined weight does not exceed the available cargo and luggage load capacity.

4. The trailer's placard is located next to or near the VIN (Certification) label at the left front of the trailer, providing the necessary tire information.

3.2.2 Trailers Over 10,000 Pounds GVWR

(**Note:** These trailers may not have a tire information placard, as it is not a requirement for all trailers to have one installed.)

1. Weigh your trailer using a public scale or another reliable method to determine its empty weight.
2. Find the Gross Vehicle Weight Rating (GVWR) on the trailer's VIN (Certification) label.
3. Subtract the trailer's empty weight from the GVWR stated on the VIN label. This difference represents the maximum available cargo capacity, which should never be exceeded for safety.

3.3 Guidelines for Assessing Tow Vehicle Load Limits

Tow Vehicle Limits

1. Locate the statement on your vehicle's placard that reads, "The combined weight of occupants and cargo should never exceed XXX lbs."
2. Calculate the combined weight of the driver and passengers who will be in the vehicle.
3. Subtract the combined weight of the driver and passengers from the "XXX" number on the placard.
4. The remaining number is the available cargo and luggage capacity. For example, if the "XXX" equals 1400 lbs. and five passengers weigh 150 lbs. each, the available capacity would be 650 lbs. (1400 - 750 = 650 lbs.).
5. Determine the combined weight of luggage and cargo

you plan to load. Ensure it doesn't exceed the available capacity.

6. If towing a trailer, remember that the trailer load will add weight to your vehicle. Check the tow vehicle's manual for how this weight impacts your vehicle's available cargo capacity.

3.4 Comprehensive Tire Terminology Guide

Accessory weight: The combined weight of optional equipment such as automatic transmission, power steering, power brakes, power windows, power seats, radio, and heater, excluding standard items that can be replaced.

Bead: The steel wire component of a tire that ensures proper fit and attachment to the rim.

Bead separation: The detachment or breakdown of the bond between the bead components.

Bias ply tire: A tire construction where the ply cords are laid at angles, typically less than 90 degrees to the centerline of the tread, alternating in opposite directions.

Carcass: The structural component of the tire, excluding the tread and sidewall rubber, which bears the load when inflated.

Chunking: The occurrence of pieces breaking off from the tread or sidewall of the tire.

Cold inflation pressure: The tire pressure measured before driving, typically when the tire has been stationary for an extended period and is at ambient temperature.

Cord: The individual strands of material (usually fabric or steel) that form the tire's plies.

Cord separation: The delamination of the cords from the surrounding rubber material in the tire.

Cracking: The formation of cracks in the tread, sidewall, or inner liner of the tire, potentially extending to the cord material.

CT (Inverted Flange Tire): A type of tire and rim system where the rim flanges point inward, and the tire fits underneath the rim, enclosing the flanges within the air cavity of the tire.

Curb weight: The weight of the vehicle with all standard equipment, including maximum fuel, oil, and coolant, along with any installed options, such as air conditioning or additional engine weight.

Extra load tire: A tire designed to operate with higher loads and at higher inflation pressures compared to a standard tire of the same size.

Groove: The channel or space between two adjacent tread ribs on a tire.

Gross Axle Weight Rating (GAWR): The maximum weight that a specific axle is rated to support, as indicated on the Certification/VIN label. Actual weight can be determined by weighing each axle on a public scale.

Gross Vehicle Weight Rating (GVWR): The maximum permissible weight of the fully loaded trailer, as specified on the Certification/VIN label. The actual weight is determined by weighing the trailer on a public

scale when not attached to the towing vehicle.

Hitch Weight: The vertical force exerted on the hitch ball by the trailer's coupler.

Inner liner: The inner layer of a tubeless tire that forms a barrier to retain the air or inflation medium within the tire.

Inner liner separation: The detachment of the inner liner from the tire's cord material within the carcass.

Intended outboard sidewall: The sidewall of a tire that is typically marked with a white-wall or the manufacturer's branding, and in the case of asymmetrical tires, the side that must always face outward when mounted on a vehicle.

Light truck (LT) tire: A tire specifically designed for use on light trucks or multipurpose passenger vehicles, though it may also be suitable for trailer use.

Load rating: The maximum load capacity of a tire is designed to support at a given inflation pressure.

Maximum load rating: The highest load a tire can carry when inflated to its maximum permissible inflation pressure.

Maximum permissible inflation pressure: The highest cold inflation pressure to which a tire can be safely inflated.

Maximum loaded vehicle weight: The total weight of a vehicle, including curb weight, accessory weight, vehicle capacity weight, and production options weight.

Measuring rim: The rim on which a tire is mounted, ensuring that the tire meets specific physical dimension requirements.

Non-pneumatic rim: A mechanical component used in non-pneumatic tire assemblies, providing support to the tire without requiring air or fluid for load bearing.

Non-pneumatic spare tire assembly: A temporary non-pneumatic tire system intended to replace a pneumatic tire on a vehicle.

Non-pneumatic tire: A tire that does not rely on air or fluid to maintain its shape and support the load, using a mechanical structure to perform the necessary functions.

Non-pneumatic tire assembly: A complete non-pneumatic tire system, including the tire and associated rim or wheel center member, designed to be mounted on a vehicle.

Normal occupant weight: Defined as 68 kilograms (150 pounds) per occupant, as specified by regulations in 49 CFR 571.110.

Occupant distribution: The specified seating arrangement of occupants in a vehicle as outlined in 49 CFR 571.110.

Open splice: Any parting or separation at the junction of the tire's tread, sidewall, or inner liner, extending to the cord material.

Outer diameter: The overall diameter of a tire when it is fully inflated and new.

Overall width: The measurement from the outermost points of the sidewalls of an inflated tire, including any elevations due to labeling, decorations, or protective bands.

Pin Weight: The downward force applied to the 5th wheel or gooseneck ball by the trailer's kingpin or gooseneck coupler.

Ply: A layer of rubber-coated cords within the tire, contributing to its structural integrity and load-bearing capacity.

Ply separation: The delamination or separation of the rubber compound between adjacent plies in the tire.

Pneumatic tire: A tire constructed from rubber, fabric, and steel, designed to carry a load by maintaining pressure from an internal gas or fluid.

Production options weight: The combined weight of options installed on a vehicle that exceeds standard equipment, such as heavy-duty brakes or specialized trim.

Radial ply tire: A tire construction where the ply cords are arranged at approximately 90 degrees to the centerline of the tread, offering better performance and durability compared to bias ply tires.

Recommended inflation pressure: The tire inflation pressure recommended by the vehicle manufacturer, typically found on the Tire Information label or Certification/VIN tag.

Reinforced tire: A tire engineered to withstand higher loads and inflation pressures compared to standard models.

Rim: A metal support structure for a tire, providing the surface on which the tire beads are seated and allowing the tire to maintain its position on the wheel.

Rim diameter: The nominal diameter of the bead seat, which corresponds to the measurement of the rim where the tire bead sits securely.

Rim size designation: A designation that includes both the rim's diameter and its width, providing complete specifications for tire fitting.

Rim type designation: The classification system used by manufacturers or industry standards to identify the style or code of a rim.

Rim width: The nominal distance between the two flanges of the rim, essentially the width where the tire sits.

Section width: The linear distance measured across the outermost points of the tire's sidewalls when the tire is inflated, excluding any added elevation from labeling, decorations, or protective bands.

Sidewall: The part of the tire that extends between the tread and the bead, playing a critical role in structural integrity.

Sidewall separation: The detachment of the rubber compound from the cords in the tire's sidewall, potentially compromising the tire's strength.

Special Trailer (ST) tire: A tire specifically designated with the "ST" marking, meaning it is designed and approved for use exclusively on trailers.

Test rim: The specific rim used for testing purposes, ensuring that the tire's performance and fit meet required standards.

Tread: The part of the tire that makes direct contact with the road, designed to provide traction and grip.

Tread rib: A continuous band of tread running circumferentially around the tire, contributing to road contact and traction.

Tread separation: The failure of the tread to remain securely attached to the tire carcass, which could lead to performance issues or failure.

Treadwear indicators (TWI): Raised markers within the tire's main grooves that signal the degree of wear, providing a visual indication of tread wear.

Vehicle capacity weight: The maximum allowable cargo and luggage weight, calculated as 68 kg (150 lbs.) multiplied by the vehicle's designated seating capacity, in addition to the rated cargo and luggage load.

Vehicle maximum load on the tire: The load on a single tire is calculated by distributing the maximum loaded vehicle weight across each axle and dividing the total by two.

Vehicle normal load on the tire: The load on a single tire is determined by dividing the share of curb weight, accessory weight, and normal occupant weight across each axle and then dividing it by two, as outlined by

regulations in 49 CFR 571.110.

Weather side: The area of the rim that is exposed and not covered by the inflated tire, typically facing outward.

Wheel center member: In non-pneumatic tire assemblies, the mechanical component that attaches to the rim, providing the connection between the rim and the vehicle, or between the tire and the vehicle when no wheel is used.

Wheel-holding fixture: The device used to secure the wheel and tire assembly during testing, ensuring safety and proper evaluation.

3.5 Tire Safety - Rides on It

The National Highway Traffic Safety Administration (NHTSA) provides a comprehensive brochure (DOT HS 809 361) covering all essential aspects of tire safety, as mandated by CFR 575.6. This document offers detailed guidelines and can be accessed and downloaded free of charge from the NHTSA website.

Visit: www.nhtsa.gov/cars/rules/TireSafety/ridesonit/tires_index.html for more information.

Research confirms that tire safety hinges on key maintenance practices, including maintaining proper tire pressure, respecting vehicle and tire load limits, avoiding road hazards, and inspecting tires for any visible damage like cuts or slashes. These preventive measures significantly reduce the risk of tire failure, such as blowouts, tread separation, or flats. Beyond ensuring safety, these practices also:

- Enhance vehicle handling for a smoother and more controlled driving experience.
- Protect against unnecessary breakdowns and accidents, safeguarding passengers and other road users.
- Boost fuel efficiency by minimizing rolling resistance.
- Extend tire life, reducing the need for premature replacements and lowering long-term costs.

Incorporating these simple but effective steps into regular vehicle care routines ensures safer and more efficient driving.

This guide offers a thorough overview of tire safety, covering essential topics such as:

- **Basic Tire Maintenance:** Key practices to ensure optimal tire performance.
- **Uniform Tire Quality Grading System:** Understanding tire ratings for informed choices.
- **Tire Fundamentals:** Insights into tire structure and functionality.
- **Tire Safety Tips:** Practical advice for safer, more reliable driving.

By integrating this knowledge into your regular vehicle maintenance routine, you can save time, avoid inconveniences, and enhance safety. A small investment of effort today can prevent the significant risks and consequences associated with tire failure or a flat tire.

3.5.1 Tire Maintenance

Proper tire maintenance is essential for improving steering, stopping ability, traction, and load-carrying performance. Underinflated tires and overloaded vehicles significantly increase the risk of tire failure. To minimize the likelihood of flat tires or blowouts, it is important to maintain correct tire pressure, follow tire and vehicle load limits, avoid road hazards, and inspect tires regularly. These steps are key to ensuring vehicle safety and performance.

3.5.2 Locating Vehicle Tire Pressure and Load Limits

Tire information placards and vehicle certification labels provide crucial details regarding tires and load limits. These labels display the following information from the vehicle manufacturer:

- **Recommended tire size:** Specifies the tire dimensions that are best suited for the vehicle.
- **Recommended tire inflation pressure:** Indicates the proper inflation pressure to ensure optimal tire performance and safety.
- **Vehicle capacity weight (VCW):** The maximum weight of occupants and cargo the vehicle is designed to carry.
- **Gross axle weight ratings (GAWR):** The maximum weight that each axle system can support, listed for both the front and rear axles.

Both the placards and certification labels are permanently affixed to the trailer, usually near the left front.

3.5.3 Understanding Tire Pressure and Load Limits

Tire inflation pressure, measured in pounds per square inch (psi), ensures proper load-carrying capacity and vehicle performance. This recommended "cold inflation pressure" is based on the vehicle's design load limit and tire size, as specified on the vehicle placard (also shown in kilopascals, kPa). The tire sidewall displays the "maximum permissible inflation pressure," which is the highest pressure allowed under normal conditions. Always check tire pressure when tires are cold for accurate measurement.

3.5.4 Safety First - Tire Maintenance

Checking your vehicle's tire pressure at least once a month is crucial for several reasons:

- Tires can naturally lose air over time.
- Sudden loss of air may occur from driving over potholes, objects, or striking curbs.
- With radial tires, under-inflation is often not visible through visual inspection.

To make tire pressure checks more convenient, it is recommended to purchase a tire pressure gauge. These can be easily found at tire dealerships, auto supply stores, and various retail outlets. The tire pressure indicated by vehicle manufacturers is the correct psi when the tire is cold. The term "cold" refers to a tire that hasn't been driven on for at least three hours. After driving, the tires heat up, increasing the air pressure. To ensure an accurate reading, check tire pressure when the tires are cold, or account for the higher pressure in warm tires.

3.5.5 Maintaining Optimal Tire Pressure

Tire Pressure

To ensure your tires are properly inflated, follow these steps:

1. Locate the recommended tire pressure on the vehicle's tire information placard, certification label, or in the owner's manual.
2. Record the tire pressure of all tires.
3. If any tire is overinflated, release air by gently pressing on the tire valve stem with your tire gauge until the correct pressure is achieved.
4. If a tire is underinflated, note the difference between the current tire pressure and the recommended pressure. This is the amount of air you need to add.
5. At a service station, add the missing air pressure to any underinflated tire.
6. Recheck all tires to ensure they have the same air pressure, unless the front and rear tires are specified to have different pressures.

If you suspect a tire is underinflated after driving, fill it to the recommended cold inflation pressure listed on your vehicle's tire information placard or certification label. Although the tire may still be slightly underinflated due to the increased pressure from driving, it is safer to have a tire with slightly lower pressure than to drive with a significantly underinflated tire. However, this is only a temporary solution—be sure

to recheck and adjust the tire pressure when the tire has cooled, and you can obtain an accurate reading.

3.5.6 Tire Size

To ensure tire safety, always purchase new tires that match the original size of your vehicle's tires or are of a size recommended by the manufacturer. You can find this information on the tire information placard, in the owner's manual, or on the sidewall of the tire you're replacing. If you're unsure about the correct size, it's advisable to consult a tire dealer for guidance.

3.5.7 Tire Tread

The tire tread is crucial for providing grip and traction, helping to prevent slipping or sliding, especially in wet or icy conditions. Generally, tires should be replaced when the tread is worn down to 2/32 of an inch. Tires have built-in tread wear indicators, which are raised sections in the tread grooves. When these indicators become level with the tread surface, it's time to replace the tire. Another method to check tread depth is by placing a penny in the tread, with Lincoln's head upside down and facing you. If the top of Lincoln's head is visible, it's time to replace the tires.

3.5.8 Tire Balance and Wheel Alignment

To prevent vibration or shaking while driving, tires must be properly balanced. This is done by adding weights to the wheel to counterbalance any heavy spots on the tire and wheel assembly. A wheel alignment adjusts the angles of the wheels to ensure they are correctly aligned with the vehicle's frame, maximizing tire life. Both balancing and alignment require specialized equipment and should be performed by a qualified

technician to ensure optimal performance.

3.5.9 Tire Repair

To properly repair a punctured tire, both a plug and a patch are necessary. The plug seals the hole, while the patch covers the area inside the tire around the puncture. Punctures in the tread can typically be repaired, as long as the hole is not too large. However, punctures in the sidewall should never be repaired. For a proper repair, the tire must be removed from the rim and thoroughly inspected before being plugged and patched.

3.5.10 Tire Fundamentals

Federal law mandates that tire manufacturers display standardized information on the sidewall of every tire. This information includes key details about the tire's characteristics and a Tire Identification Number (TIN). The TIN is crucial for safety standard certification and helps track tires in the event of a recall.

3.5.10.1 Passenger Vehicle Tire Terminology

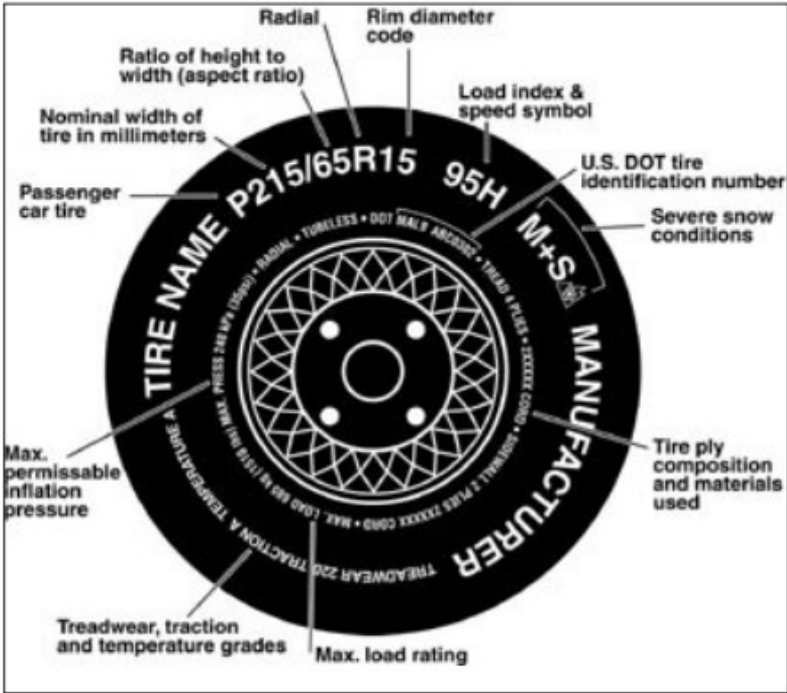

- **P:** Indicates the tire is for passenger vehicles.
- **Next number:** A three-digit number showing the tire's width in millimeters from sidewall to sidewall. A larger number means a wider tire.
- **Next number:** A two-digit number known as the aspect ratio, indicating the ratio of the tire's height to its width. Aspect ratios of 70 or lower suggest a shorter sidewall for improved steering and handling on dry roads.
- **R:** Stands for "radial," which indicates radial ply construction, the industry standard for the last 20 years.

- **Next number:** A two-digit number representing the wheel or rim diameter in inches. When changing wheel size, new tires matching the new rim diameter are needed.
- **Next number:** A two- or three-digit load index, indicating how much weight the tire can support. Check the vehicle's owner's manual or consult a tire dealer for more details. Note that this information is not always provided.
- **M+S:** Indicates the tire has mud and snow capabilities. Most radial tires feature this marking, suggesting they perform adequately in such conditions.
- **Speed Rating:** Denotes the maximum speed at which the tire can safely be driven for extended periods.
- **U.S. DOT Tire Identification Number:** Begins with "DOT," showing that the tire complies with federal standards. It includes the plant code where it was manufactured, which is indicated by either two numbers or letters, followed by the week and year the tire was manufactured (e.g., "2798" means the 27th week of 1998). Additional numbers are for marketing purposes and may be used for recalls.
- **Tire Ply Composition and Materials Used:** Shows the number of rubber-coated fabric layers (plies) in the tire. Generally, more plies allow the tire to support more weight. The tire's material composition, such as steel, nylon, or polyester, is also indicated.
- **Maximum Load Rating:** Displays the maximum load the tire can safely carry, stated in kilograms and pounds.

- **Maximum Permissible Inflation Pressure:** The highest air pressure the tire should ever have under normal driving conditions.

3.5.10.2 UTQGS Terminology

Treadwear, Traction, and Temperature Ratings

- **Treadwear Number:** Reflects the tire's wear rate. A higher number suggests longer-lasting tread. For instance, a tire with a grade of 400 should wear down at half the rate of one graded 200.
- **Traction Letter:** Indicates the tire's ability to stop on wet roads. Higher grades enable shorter stopping distances on wet surfaces. Traction grades range from highest (AA) to lowest (C).
- **Temperature Letter:** Denotes the tire's resistance to heat buildup when properly inflated and not overloaded. Excessive speed, underinflation, or overloading can cause heat buildup and potential tire failure. Grades for heat resistance are A (highest), B, and C (lowest).

(totaling six or more tires on the vehicle).

- **Max. Load Single (kg/lbs) at kPa (psi) Cold:** This indicates the maximum load capacity and tire pressure when the tire is used singly on the axle.
- **Load Range:** This defines the tire's load-carrying capabilities and its corresponding inflation pressure limits.

These markings are critical for ensuring the tire's proper use and safety under various loading conditions.

3.5.10.4 Tire Safety

Preventing Tire Damage

- Reduce speed when driving over potholes or obstacles on the road.
- Avoid running over curbs, striking foreign objects, or hitting the curb when parking.

Tire Safety Checklist

- Regularly check tire pressure, including the spare, at least once a month.
- Inspect tires for uneven tread wear, cracks, embedded foreign objects, or other signs of damage.
- Remove glass shards or other debris lodged in the tread.
- Ensure all tire valves have secure valve caps.
- Check tire pressure before embarking on long trips.
- Avoid overloading your vehicle; consult the Tire Information Placard or Owner's Manual for the maximum load capacity.

4. Connecting to Tow Vehicle

Adhere to all safety guidelines and instructions provided in this manual to ensure the safety of individuals, protection of cargo, and extended durability of the trailer.

4.1 Tow Vehicle and Hitch

Ensuring that the tow vehicle and hitch are correctly selected and matched to the trailer's Gross Vehicle Weight Rating (GVWR) is critical to safety. Failure to do so could result in an accident, causing serious injury or death. If you already own a tow vehicle, confirm its towing capacity and ensure the trailer's rated capacity does not exceed the vehicle's rated towing capability.

 **DANGER**

Use of a tow vehicle with a towing capacity less than the load rating of the trailer can result in loss of control, and may lead to death or serious injury.

Use of a hitch with a load rating less than the load rating of the trailer can result in loss of control and may lead to death or serious injury.

Verify hitch and tow vehicle are rated for the Gross Vehicle Weight Rating of your trailer.

4.1.1 Trailer Certification / VIN Tag

The Certification/Vehicle Identification Number (VIN) tag, located on the front left side of the trailer, provides essential safety information about your trailer. Key details included on the Certification/VIN tag are:

- **Manufacturer:** Name of the trailer manufacturer.
- **Date of Manufacture:** Month and year the trailer was manufactured.
- **GVWR (Gross Vehicle Weight Rating):** The maximum allowable weight of the trailer and its contents, including the trailer itself and all cargo or supplies.
- **GAWR (Gross Axle Weight Rating):** The maximum weight each axle can support, determined by the lowest rating among the axle, wheel, or tires. Note that GAWR may be less than GVWR since part of the trailer's load is carried by the tow vehicle.
- **Tire Size:** Specifies the tire size and load range for the trailer.
- **Rim Size:** Specifies the rim size and load range for the trailer.
- **PSI:** Recommended tire air pressure (in Kilopascals or Pounds per Square Inch) measured when the tires are cold.
- **VIN:** The unique Vehicle Identification Number for the trailer.
- **Vehicle Type:** The model or style of the trailer.
- **Certification Statement:** Confirms the trailer meets all Federal Motor Vehicle Safety Standards effective on the manufacturing date.

This tag ensures that users have the critical data needed for safe operation and compliance with safety standards.

4.1.2 Outfitting a Tow Vehicle

When preparing a new or older vehicle to tow a trailer, it's important to consult the vehicle dealer for advice on the appropriate equipment needed for towing. Vehicle manufacturers provide the maximum towing capacities for each model, along with the Gross Combined Weight Rating (GCWR). It's important to note that no amount of reinforcement will increase the towing capacity of a vehicle. For example, a truck with 100 horsepower and a 2,500-pound capacity will never have the same towing capability as a truck with 300 horsepower and a 5,000-pound capacity.

4.2 Attaching and Detaching the Trailer

The process of attaching and detaching a trailer is called coupling. Ensuring the trailer is securely coupled to the tow vehicle is crucial for safety, as any loss of coupling can lead to severe injury or even death. To ensure a safe and secure connection, it is important to follow all instructions related to coupling.

Key components involved in securely coupling a trailer include:

- **Coupling:** The mechanism that connects the trailer to the tow vehicle. This does not include structural components, trailer frame extensions, or brake controllers.
- **Hitch:** The mechanism that connects to the tow vehicle, including the ball support platform, the hitch ball, and any extensions or components, such as bumpers, intended for towing.
- **Safety chains:** Chains permanently attached to the

trailer that ensure the trailer stays connected to the tow vehicle in the event the primary connection fails. With properly installed safety chains, the trailer tongue will not drag along the road.

- **Trailer lighting (and braking) connector:** The device that connects the electrical system of the tow vehicle to the trailer, powering the lights and, if applicable, the trailer brakes.

- **Breakaway switch:** A safety feature that activates the trailer's brakes if the trailer becomes detached from the tow vehicle. The breakaway switch uses a battery on the trailer to power the brakes independently of the tow vehicle. A lanyard attached to the tow vehicle activates the switch by pulling a pin if uncoupling occurs. It is essential to check the battery charge of the breakaway system and ensure the lanyard has sufficient slack to engage the switch only if the connection is lost.

- **Jack:** A device used to raise or lower the trailer tongue to facilitate coupling and uncoupling.

*Always ensure these components are in good working order before each trip.

 WARNING
<p>An improperly coupled trailer can result in death or serious injury. Do not move the trailer until:</p> <ul style="list-style-type: none">• Coupler is secured and locked to hitch.• Safety chains are secured to tow vehicle.• Trailer jack(s) are fully retracted.• Trailer brakes are checked.• Tires and wheels are checked.• Breakaway switch is connected to tow vehicle;• The trailer lights are connected and checked.• Load is secured to trailer.

4.3 Connecting Trailer to Tow Vehicle

Your trailer may come with either a ball hitch coupler or a ring and pintle coupler. Consult the relevant section for details about your trailer's specific coupler type.

4.3.1 Ball Hitch Coupler

A ball hitch coupler connects to a tow ball mounted on or beneath the rear bumper of the tow vehicle.

The trailer is equipped with a ball hitch coupler designed to match its size and weight specifications. The coupler's load rating and the required ball size are indicated on the trailer tongue.

Requirements for Safe Towing:

- Provide a hitch and ball for your tow vehicle that meets or exceeds the trailer's Gross Vehicle Weight Rating (GVWR).
- Ensure the ball size matches the coupler size. Mismatched, loose, worn, or underrated hitch balls can cause the trailer to detach, potentially leading to serious injury or death.
- The tow vehicle, hitch, and ball must all have a towing capacity equal to or greater than the trailer's GVWR.

Always confirm the ball size and load rating, as marked on the ball, and check the hitch capacity, which is labeled on the hitch. Proper compatibility is crucial for safe towing.

4.3.1.1 Pre-Coupling Preparation Checklist

1. Ensure the hitch ball size and rating match the coupler size and rating. Both are marked for easy identification.

 WARNING
<p>Coupler-to-hitch mismatch can result in uncoupling, leading to death or serious injury.</p> <p>Be sure the LOAD RATING of the hitch ball is equal or greater than the load rating of the coupler.</p> <p>Be sure the SIZE of the hitch ball matches the size of the coupler.</p>

2. Clean the hitch ball and inspect it for flat spots, cracks, or pits.

 WARNING
<p>A worn, cracked or corroded hitch ball can fail while towing, and may result in death or serious injury.</p> <p>Before coupling trailer, inspect the hitch ball for wear, corrosion and cracks.</p> <p>Replace worn or damaged hitch ball.</p>

3. Verify the hitch ball is securely fastened. Rock it to check tightness and confirm the ball nut is firmly against the lock washer and hitch frame.

4. Clean the coupler inside and out. Inspect it for cracks, deformations, and worn spots, feeling for any pits inside the coupler.

5. Ensure the coupler is securely attached to the trailer tongue, with all fasteners visibly tight against the trailer frame.

⚠ WARNING

A loose hitch ball nut can result in uncoupling, leading to death or serious injury.

Make sure the hitch ball is tight to the hitch before coupling the trailer.

6. Raise the coupler so that its bottom surface is positioned above the hitch ball.

4.3.1.2 Steps to Prepare Coupler and Hitch

1. Coat the hitch ball and the inside of the coupler with a thin layer of automotive bearing grease.

2. Remove the safety latch pin and unlock the coupler mechanism. With the coupler in the open position, it should be able to drop fully onto the hitch ball. Follow the coupler instructions for detailed steps on setting it to the "open" position.

3. Gradually reverse the tow vehicle until the hitch ball is aligned with or close to the coupler.

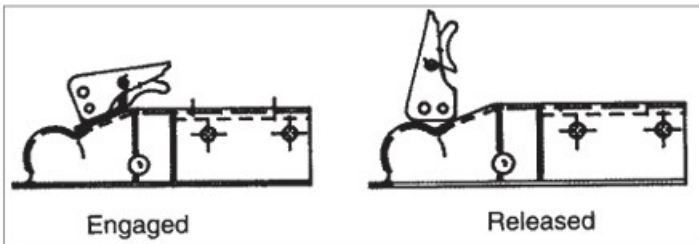

Your trailer may feature a different style of coupler. In that case, refer to the operating instructions provided by the coupler manufacturer.

4.3.1.3 Hitch Trailer to Tow Vehicle

1. Lower the trailer tongue until the coupler is fully engaged with the hitch ball. If the coupler does not align with the ball, adjust the position of the tow vehicle.
2. Close the latch and engage the coupler's locking mechanism. When properly engaged, the locking mechanism securely attaches the coupler to the hitch ball.
3. Insert the safety lock pin through the hole in the locking mechanism.
4. Confirm that the coupler is fully seated on the hitch ball and the locking mechanism is engaged. A correctly engaged mechanism should allow the coupler to lift the rear of the tow vehicle. Test this by using the trailer jack to raise the tow vehicle's rear by at least 1 inch once the coupler is locked to the hitch.

NOTICE

The tongue jack can be damaged by overloading. Do not use the tongue jack to raise the tow vehicle more than 1 inch.

5. If the coupler cannot be securely attached to the hitch ball, do not tow the trailer. Contact your dealer for assistance.
6. Lower the trailer until the entire tongue weight is supported by the hitch, then continue retracting the jack to its fully retracted position.



CAUTION

Drop leg jacks may be spring loaded.

If so, they will rapidly return to the raise position when released.

Keep clear when releasing drop legs.

7. Fully retract the jack drop leg, if equipped.

Proceed to Section 4.3.3, "Connect Safety Chains," to continue connecting the trailer to the tow vehicle.

4.3.2 Ring and Pintle Coupler

The trailer's ring connects to the pintle located on or beneath the rear bumper of the tow vehicle.

We have used a ring suitable for the trailer's size and weight. The load rating of the ring and the required pintle size are indicated on the trailer tongue.

For safe towing, you must provide a pintle for your tow vehicle, ensuring the load rating of the hitch and pintle is equal to or greater than the trailer's specifications. The pintle size must match the ring size. If the pintle is too small, too large, underrated, loose, or worn, the trailer may detach from the tow vehicle, potentially causing serious injury or death.

The tow vehicle, hitch, and pintle must have a towing capacity equal to or greater than the trailer's Gross Vehicle Weight Rating (GVWR).

Always ensure that the pintle matches the ring size for proper fitment. The pintle's size and load rating are marked on the pintle, while the ring capacity is marked on the ring.

4.3.2.1 Before Coupling Trailer to Tow Vehicle

1. Ensure the pintle size and rating match the size and rating of the ring. Both the hitch ring and pintle are marked with their size and rating.



WARNING

Ring-to-pintle mismatch can result in uncoupling, leading to death or serious injury.

Be sure the LOAD RATING of the pintle is equal or greater than the load rating of the ring.

Be sure the SIZE of the pintle matches the size of the ring.

2. Clean the pintle and inspect it visually and by touch for any flat spots, cracks, or pits.



WARNING

A worn, cracked or corroded pintle can fail while towing, and may result in death or serious injury.

Before coupling trailer, inspect the pintle for wear, corrosion and cracks.

Replace worn or damaged pintle.

3. Rock the pintle to confirm it is tightly secured to the hitch and check that the pintle fasteners are firmly in place against the hitch frame.

4. Clean the inside and outside of the ring and visually inspect it for cracks or deformations. Feel the inside of the ring for any worn spots or pits.

5. Confirm that the ring is securely attached to the trailer tongue, with all fasteners solidly in place against the trailer frame.



WARNING

A loose pintle can result in uncoupling, leading to death or serious injury.

Make sure the pintle is tight to the hitch before coupling the trailer.

6. Ensure the bottom surface of the ring is positioned above the top of the open pintle.

4.3.2.2 Prepare Ring and Pintle

1. Apply a thin layer of automotive bearing grease to the inside of the pintle.

2. Remove the safety latch pin and open the pintle locking mechanism.

3. With the pintle in the open position, the ring should be able to drop fully onto it.

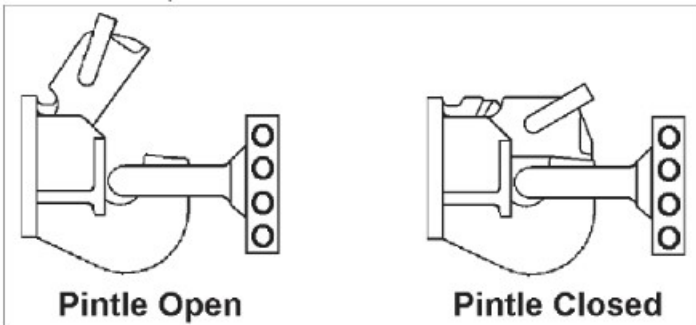

4. Refer to the coupler instructions for detailed steps on placing the pintle in the "open" position.

5. Gradually reverse the tow vehicle until the pintle is aligned under the ring.

4.3.2.3 Hitch Trailer to Tow Vehicle

1. Lower the trailer tongue until the coupler is fully engaged with the hitch ball. If the coupler does not align with the ball, adjust the position of the tow vehicle.
2. Close the latch and engage the coupler's locking mechanism. When properly engaged, the locking mechanism securely attaches the coupler to the hitch ball.
3. Insert the safety lock pin through the hole in the locking mechanism.
4. Confirm that the coupler is fully seated on the hitch ball and the locking mechanism is engaged. A correctly engaged mechanism should allow the coupler to lift the rear of the tow vehicle. Test this by using the trailer jack to raise the tow vehicle's rear by at least 1 inch once the coupler is locked to the hitch.

NOTICE

The tongue jack can be damaged by overloading. Do not use the tongue jack to raise the tow vehicle more than 1 inch.

5. If the coupler cannot be securely attached to the hitch ball, do not tow the trailer. Contact your dealer for assistance.
6. Lower the trailer until the entire tongue weight is supported by the hitch, then continue retracting the jack to its fully retracted position.



CAUTION

Drop leg jacks may be spring loaded.

If so, they will rapidly return to the raise position when released.

Keep clear when releasing drop legs.

7. Fully retract the jack drop leg, if equipped.

Proceed to Section 4.3.3, "Connect Safety Chains," to continue connecting the trailer to the tow vehicle.

4.3.3 Connect Safety Chains

1. Visually inspect the safety chains and hooks for any signs of wear or damage. Replace any worn or damaged safety chains or hooks before towing.
2. The safety chains must crisscross under the coupler to ensure that if the trailer uncouples, the chains can hold the tongue above the road. Attach the chains around a frame member of the tow vehicle or to holes provided in the hitch system, but avoid attaching them to any interchangeable part of the hitch assembly.
3. Attach the hooks from underneath the hole; do not simply drop them into the hole.
4. Ensure there is enough slack in the chains to allow for tight turns, but make sure the chains do not drag on the road surface.

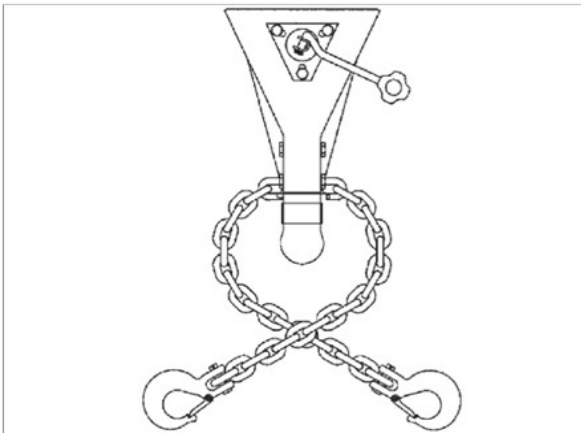



WARNING

Improper rigging of the safety chains can result in loss of control of the trailer and tow vehicle, leading to death or serious injury, if the trailer uncouples from the tow vehicle.

Cross chains underneath hitch and coupler with enough slack to permit turning and to hold tongue up, if the trailer comes loose.

Fasten chains to frame of tow vehicle.

Do not fasten chains to any part of the hitch unless the hitch has holes or loops specifically for that purpose.

4.3.4 Proper Connection of Trailer Lights

1. Attach the trailer lights to the tow vehicle's electrical system using the trailer electrical cable.
2. Verify that all lights are functioning correctly. Repair or replace any non-working lights before towing the trailer.
3. Test the electric brakes to ensure they are working properly using the brake controller mounted in the tow vehicle's cab.



WARNING

Improper electrical connection between the tow vehicle and the trailer will result in inoperable lights and electric brakes, and can lead to collision.

Before each tow:

- **Check that the electric brakes work by operating the brake controller inside the tow vehicle.**
- **Check that all lights and turn signals work.**

4.3.5 Attach Breakaway Brake Lanyard (If Equipped)

In the event of a coupler or hitch failure, a properly connected and functioning breakaway brake system will activate the trailer brakes. The safety chains will maintain the connection between the tow vehicle and trailer, allowing the trailer to come to a controlled stop as the brakes are applied.

Attach the lanyard to the tow vehicle in a way that ensures the hydraulic actuator engages or the electric brake pullpin is pulled out before all the slack in the safety chains is taken up. Do not connect the lanyard to a safety chain, hitch ball, or hitch ball assembly, as this would prevent the breakaway brake system from functioning properly when needed.

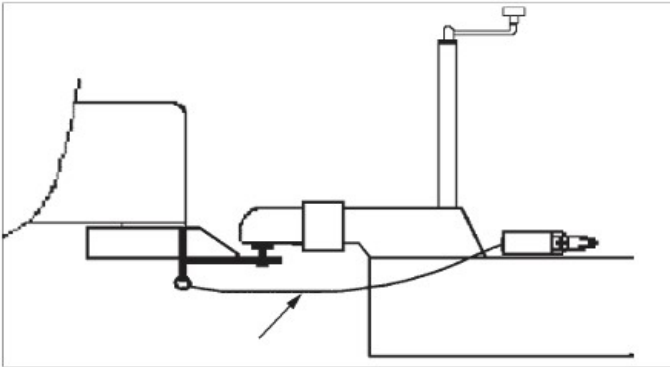

4.3.5.1 Test Your Electric Brakes

If your trailer is equipped with electric brakes, your tow vehicle should have an electric brake controller that sends power to the trailer's brakes. Before using the trailer on the road, you must test the brake controller by attempting to operate the trailer.

While towing the trailer at speeds under 5 mph, manually engage the brake controller in the tow

vehicle. You should feel the trailer's brakes activating. If the brakes do not respond, the brake system must be inspected to identify the issue, and necessary repairs must be made before the trailer is used. Contact your dealer or a qualified brake specialist for assistance.

Perform this check each time you tow the trailer to ensure the brake system is functioning properly.

4.3.5.2 Test Your Electric Breakaway Brakes

The breakaway brake system consists of a battery, a switch with a pullpin and lanyard, and a brake controller. Be sure to follow both the instructions provided here and those from the breakaway brake manufacturer. If these instructions are unavailable, reach out to your dealer for assistance.

In most cases, dump trailers use the hoist battery to power the breakaway brakes. If your trailer is not set up this way, a separate small breakaway battery will be mounted near the switch.

Most trailers are wired to charge the breakaway battery from the tow vehicle. If your vehicle does not provide this power, you will need to periodically charge the battery with a commercial charger to ensure it remains properly charged.

 CAUTION
Extreme cold weather can degrade battery performance and cause brakes to not operate properly.
Check battery charge level before towing.

Do not tow the trailer if the brake battery is low. A discharged battery will not activate the brakes in the event that the trailer becomes uncoupled from the tow vehicle. Ensure the battery is fully charged before towing the trailer.

To test the breakaway brake battery, remove the pullpin from the switch and try to pull the trailer forward. You should feel resistance, though the wheels may not fully lock. If the brakes don't function, do not tow the trailer until the brakes or battery are repaired. Replace the pullpin immediately, as the breakaway brake battery will discharge quickly when the pullpin is removed.

 WARNING
<p>An ineffective breakaway brake system can result in a runaway trailer, leading to death or serious injury if the coupler fails.</p> <p>Test the function of the breakaway brake system before towing trailer. Do not tow trailer if breakaway brake system is not working; have it serviced or repaired.</p> <p>Connect breakaway lanyard to the tow vehicle, NOT to the safety chain, ball, pintle, hitch, or support.</p>

Do not tow the trailer with the breakaway brake system activated, as this can cause the brakes to overheat and potentially lead to permanent brake failure.

 WARNING
<p>Failure to replace the pullpin can result in ineffective brakes, leading to loss of control, serious injury or death.</p>

If you don't use your trailer for three or more months, or during the winter months

- Store the battery indoors.
- Charge the battery every three months.

Be sure to replace the breakaway brake battery as recommended by the manufacturer.

4.3.5.3 Test Surge Brakes

Hydraulic surge actuator systems offer automatic and smooth trailer braking without requiring special input from the tow vehicle driver. While this is highly convenient, it can sometimes be challenging to determine if the surge brake system is functioning properly. The following steps outline a quick field test to verify that the trailer brake system is operational.



WARNING

The field-test procedure indicates only if the trailer brake system is functional, but **DOES NOT** provide information on how efficiently it will operate.

Regular inspection, maintenance, and adjustment of all brake system components (including the surge actuator, tubing, hoses, brake clusters, drums, and associated hardware/support structure) are still required to ensure maximum brake performance and smooth, even brake operation.

Move the trailer onto flat, level ground and pull it forward for a few feet before parking. This ensures that trailers with free-backing brakes are in their normal operating mode. Disconnect the trailer from the tow vehicle and lift the trailer's tongue until it is horizontal.

Next, connect the safety chains (NOT the breakaway cable) to form a loop underneath the actuator's coupler. Place wheel chock blocks two feet behind the trailer to prevent it from moving.

Position a sturdy board, such as a 2-inch by 4-inch piece of lumber, into the chain loop beneath the coupler. The board should be at least 4 feet long, extending several feet above the actuator. Keep the end of the board slightly off the ground and position it to press against the front of the actuator's coupler. Apply pressure to the top of the board to engage the actuator and its internal master cylinder.

If the trailer brake system is functioning properly, the brakes will activate, preventing the trailer from rolling away. With uni-servo or duo-servo brakes, the trailer should move only a few inches. Free-backing brakes will resist movement initially, but continued force will switch them into free-backing mode, allowing the trailer to move backward.

If you have uni-servo or duo-servo brakes and the trailer rolls away with little resistance, or if you have free-backing brakes and the trailer moves without initial resistance, the brakes are not working properly. The brake system needs to be inspected and repaired before use. Always conduct this test before towing to verify that the surge brake system is operational.

4.3.5.4 Test Surge Breakaway System

Before towing, ensure that the breakaway lever and lanyard are correctly positioned. If the lanyard has been accidentally pulled or moved during use, it must be reset before the trailer is towed.

Refer to the Surge Brake Actuator manual for the proper procedure to reset and test the breakaway system.

 WARNING
<p>The breakaway system is designed to operate if the trailer separates from the tow vehicle.</p> <p>DO NOT use the breakaway system as a parking brake.</p>

4.4 Uncouple Trailer

To uncouple the trailer from the tow vehicle, follow these steps:

1. Park the trailer on a firm, level surface and block the trailer tires.
2. Disconnect the electrical connector.
3. Unplug the breakaway brake switch lanyard.
4. Detach the safety chains from the tow vehicle.
5. Unlock and open the coupler.
6. Before extending the jack, ensure the ground surface under the jack pad can support the tongue load.
7. Rotate the jack handle to extend the jack and transfer the trailer tongue's weight to the jack.
8. Raise the trailer coupler above the tow vehicle hitch.
9. Drive the tow vehicle forward to fully disconnect.

4.5 Tongue Weight

Proper Tongue Weight for Trailer Stability

It is crucial that a portion of the trailer's load is carried by the tow vehicle, with the trailer tongue exerting a downward force on the hitch. This is vital for two main reasons:

1. **Tow Vehicle Control:** Proper tongue weight ensures the tow vehicle can maintain control over the combined vehicle/trailer system. If the tongue pulls upward on the hitch—often due to an overloaded trailer behind its axles—the rear wheels of the tow vehicle may lose traction, resulting in loss of control. Similarly, insufficient tongue weight can cause instability, especially at high speeds. The faster you drive, the higher the likelihood that the trailer will sway.

2. **Preventing Jack-Knife and Steering Loss:** Excessive tongue weight can lead to a jack-knife situation, where the tow vehicle's front wheels become too lightly loaded, reducing steering control and traction, especially if the front wheels are powered.

Axle and Tongue Weight Balance

In addition to ensuring vehicle control, proper tongue weight is necessary to prevent the trailer's axle(s) from exceeding their Gross Axle Weight Rating (GAWR).

The following table outlines a general rule of thumb for tongue weight, based on the total weight of the trailer and its cargo (Gross Trailer Weight, or "GTW"). For example, a 6,000-pound loaded trailer should have 10-15% of its total weight (600-900 pounds) on the hitch.

Tongue Weight as a Percentage of Loaded Trailer Weight	
Type of Hitch	Percentage
Ball Hitch or Ring & Pintle	10-15% for large trailers 6-10% for small trailers

WARNING

Improper tongue weight (load distribution) can result in loss of control of the trailer, leading to death or serious injury.

Make certain that tongue weight is within the allowable range.

Be sure to:

- Distribute the load evenly, right and left.
- Keep the center of gravity low.
- Distribute the load front-to-rear to provide proper tongue weight (see chart).

4.5.1 How to Check Tongue Weight

To accurately measure tongue weight, ensure the tow vehicle and trailer are on level ground, simulating towing conditions. Follow these steps at a certified scale, such as at a truck stop or grain elevator:

1. Weigh the Tow Vehicle Alone:

- Position only the tow vehicle on the scale.
- Obtain a weight ticket to ensure this weight is less than the vehicle's Gross Vehicle Weight Rating (GVWR).

2. Weigh the Uncoupled Trailer:

- Pull the entire trailer onto the scale and uncouple it from the tow vehicle.
- Obtain a weight ticket for the total trailer weight.

3. Weigh the Trailer Axles:

- Reconnect the trailer to the tow vehicle.
- Drive the tow vehicle off the scale, leaving only the trailer axles on the scale.
- Obtain a ticket showing the trailer's axle weight.

4. Calculate Tongue Weight:

- Subtract the axle weight from the total trailer weight to determine the tongue weight.

5. Verify Combined Weight:

- While at the scale, weigh the entire vehicle and trailer combination.
- Ensure this weight is less than the tow vehicle's Gross Combined Weight Rating (GCWR).

6. Optional Axle Check:

Certain scales provide the option to measure individual axle weights.

- If available, weigh the tow vehicle's front and rear axles separately.
- Confirm the axle weights remain proportional to the tow vehicle's weight alone and that the rear axle is not overloaded.

These steps ensure your vehicle and trailer are within

safe weight limits and properly balanced for towing.

4.6 Adjust Hitch Height (If Equipped)

The hitch height on the trailer must be set so that when the trailer is loaded to its rated capacity, it remains level when connected to the tow vehicle. A level trailer ensures that weight is distributed evenly across the axles.

This adjustment can be performed by your dealer or a trailer service center, or you can follow these steps to adjust the hitch height yourself. If the trailer doesn't have an adjustable hitch, an offset ball mount may be available from your hitch manufacturer.

 WARNING
Improper hitch height adjustment can result in overloaded tires, blowout and loss of control, leading to death or serious injury.
Adjust the hitch height so that the loaded trailer is level.

1. **Connect the trailer to the tow vehicle** and load it to its rated capacity. Refer to the Loading and Unloading section for guidance.
2. **Park the tow vehicle and trailer** on a firm, level surface.
3. **Stand clear of the trailer** and visually check if the trailer is level from front to rear. If the front of the trailer is higher than the rear, the hitch needs to be raised. If the front is lower than the rear, the hitch needs to be lowered.
4. **Uncouple the trailer from the tow vehicle** by following the Uncoupling procedure.
5. **Remove the lock nuts and bolts** from the hitch. Discard the lock nuts and inspect the bolts for any

damage. If damaged, replace the bolts with the correct size and grade, and contact your dealer if necessary.

 WARNING
<p>Used lock nuts are prone to loosen, resulting in the hitch separating from the trailer, which can lead to death or serious injury.</p> <p>NEVER re-use a lock nut.</p> <p>Use new lock nuts each time the hitch height is adjusted.</p> <p>Contact your dealer for the proper grade and size of lock nut.</p>

6. **Raise or lower the hitch** as needed to achieve the desired trailer level.
7. **Install the bolts and new lock nuts** onto the hitch.
8. **Tighten the lock nuts** to the torque specifications provided by your dealer.
9. **Reconnect the trailer to the tow vehicle** and verify that the trailer is level from front to rear. Adjust if necessary.
10. **Unload the trailer** following the procedures outlined in the Loading and Unloading section.

5. Safe Trailer Loading Guidelines

Improper trailer loading is a leading cause of accidents and fatalities. To load a trailer safely, consider these critical factors:

1. Key Considerations:

- Overall Load Weight: Ensure the total weight does not exceed the trailer's Gross Vehicle Weight Rating (GVWR).
- Load Weight Distribution: Distribute weight evenly to prevent overloading any part of the trailer.
- Proper Tongue Weight: Maintain the correct percentage of the load on the tongue for stability.
- Securing the Load: Use proper tie-downs to prevent items from shifting during transport.

2. Weight Distribution:

- The trailer axles bear most of the total load (Gross Vehicle Weight or GVW), while the tow vehicle hitch supports the remainder.
- An improperly distributed load can lead to trailer sway or an overloaded tow vehicle rear axle.

3. Tongue Weight:

- Ensure the tongue and hitch carry the correct portion of the trailer weight to maintain towing stability. Refer to the "Tongue Weight" section for detailed guidelines.

4. Axle Load and Balance:

- Avoid overloading any axle by evenly distributing weight from front to rear.
- For tandem or triple axle trailers, balance the load to

keep axle ratings within limits.

5. Center of Gravity:

- Load heavy items low and directly over the axles.
- Maintain side-to-side balance and ensure proper tongue weight as you add items.

6. Important Safety Notes:

- Never exceed the trailer's GVWR.
- Avoid transporting passengers, hazardous substances, or flammable liquids, except for fuel in the tanks of equipment or vehicles being hauled.

Reminder: Properly loading your trailer ensures stability, prevents accidents, and protects your equipment. Always follow manufacturer specifications for safe operation.

 WARNING
<p>Do not transport flammable, explosive, poisonous or other dangerous materials on your trailer.</p> <p>The exception is fuel in the tank of a vehicle or equipment being hauled.</p>

 WARNING
<p>Do not transport people on your trailer. Besides putting their lives at risk, the transport of people on a trailer is illegal.</p>

5.1 Loading Trailer

5.1.1 Preparing Trailer for Loading

1. Inspect the trailer floor for any damage or weakness.
2. Check tie-down rings and track systems for signs of damage, looseness, or bending to ensure secure load anchoring before loading the trailer.

 WARNING
<p>Damaged or loose tie down rings or track can break, allowing cargo to become loose.</p>
<p>Loose cargo can shift the center of gravity, and result in loss of control of the trailer.</p>
<p>Inspect and test tie downs and track before loading cargo.</p>
<p>Do not use a damaged or loose tie downs or track to secure cargo.</p>

3. Park the tow vehicle and trailer on a firm, level surface to maintain stability.
4. Clear the area around the trailer to ensure a safe and unobstructed loading process.

5.1.2 Loading a Rigid Deck Trailer

1. Couple the trailer securely to the tow vehicle to ensure stability during loading.

 WARNING
<p>Trailer must be coupled to tow vehicle before loading trailer.</p>

2. Lower the rear stabilizers, if equipped, or place blocking under the rear of the trailer to prevent the front from lifting during loading.

 CAUTION
Use a safe lifting procedure to avoid injury when handling ramps.

3. Take the ramps out of their storage position and secure them to the rear of the trailer. Adjust the ramp positions to align with the tires or tracks of the equipment.

 WARNING
Load can suddenly move or topple, which can result in death or serious injury.
Do not load or unload trailer unless coupled to tow vehicle and is on a firm and level surface.

NOTICE
<i>Ramps are not rated for load bearing capacity. They will NOT support the load bearing capacity of the trailer.</i>
<i>Do not overload ramps.</i>

4. Load the cargo onto the trailer, ensuring approximately 60% of the load is in the front half for proper balance.

5. Secure the cargo to the trailer using suitable straps, chains, and tensioning devices. Refer to www.fmcsa.dot.gov for cargo securement regulations.

6. Remove the ramps and return them to their storage position.

7. Secure the ramps to the trailer.

8. Raise the rear stabilizers, if equipped, or remove the blocking from under the rear of the trailer.

5.1.3 Loading a Tilt Deck Trailer

Tilt deck trailers may feature either a manual or hydraulic tilt deck for ease of loading and unloading.

5.1.3.1 Manual Tilt Trailer

1. Ensure the trailer is securely coupled to the tow vehicle.

 WARNING
Trailer must be coupled to tow vehicle before loading trailer.

2. Unlock the deck latch pin to allow the trailer deck to pivot for loading.

 WARNING
Loading a pivoting-deck trailer before retracting the deck catch pin can crack the catch pin, which can cause loss of cargo or loss of control of the trailer. Death or serious injury may result.
Before loading the trailer, retract the deck catch pin.
If the deck catch pin becomes bent, do not straighten it. Replace the deck catch pin before towing the load.

3. Load the cargo onto the trailer, positioning approximately 60% of it in the front half. As the cargo is moved forward, the deck will pivot down into the driving position.

4. Lock the deck into the driving position by extending the deck catch pin. Ensure the catch properly engages the hole in the pivoting deck.

 WARNING
<p>An unlocked pivoting deck can result in loss of cargo or loss of control of the trailer, which can result in death or serious injury.</p>
<p>Before towing the trailer:</p> <ul style="list-style-type: none">• Lock the pivoting deck in the driving position.• Verify that the catch engages the hole in the pivoting deck.

5. Secure the cargo to the trailer using appropriate straps, chains, and tensioning devices. For detailed cargo securement regulations, refer to www.fmcsa.dot.gov.

 WARNING
<p>Shifting cargo can result in loss of control of the trailer, and can lead to death or serious injury.</p>
<p>Tie down all loads with proper sized fasteners, chains, straps, etc.</p>

5.1.3.2 Hydraulic Tilt Trailer

1. Couple the trailer to the tow vehicle securely.

 WARNING
<p>Trailer must be coupled to tow vehicle before loading trailer.</p>

2. Familiarize yourself with the hoist operating procedure before using the tilt deck.
3. Locate the tilt deck controller and position yourself safely, clear of the tilt deck.
4. Press and hold the button to raise the tilt deck, releasing it when the rear touches the ground.
5. Load cargo with approximately 60% of the weight in the front half of the trailer.
6. Secure the cargo to prevent movement during transport.
7. Press and hold the button to lower the tilt deck, releasing it once it is in the driving position.
8. Secure the load to the trailer using proper straps, chains, and tensioning devices. Refer to www.fmcsa.dot.gov for cargo securement regulations.
9. Stow the controller after operation.

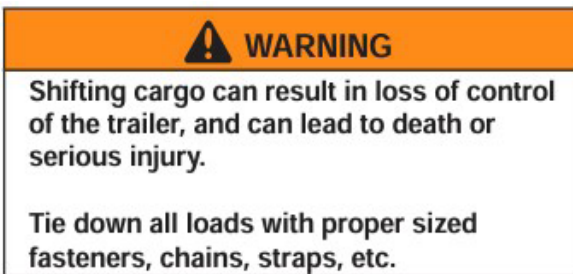

5.2 Unload Trailer

5.2.1 Unload Manual Tilt Trailer

1. Couple the trailer to the tow vehicle.



WARNING

Trailer must be coupled to tow vehicle before unloading trailer.

2. Park the tow vehicle and trailer on a firm and level surface.
3. Clear the area around the trailer.
4. Remove chains, straps, and tensioning devices.
5. Release the deck latch pin to pivot the trailer deck for unloading.



WARNING

Unloading a pivoting-deck trailer before retracting the deck catch pin can crack the catch pin, which can cause loss of cargo or loss of control of the trailer. Death or serious injury may result.

Before unloading the trailer, retract the deck catch pin.

If the deck catch pin becomes bent, do not straighten it. Replace the deck catch pin before towing the load.

6. Carefully move the cargo toward the rear of the trailer. The deck will pivot down into the unload position as the cargo moves rearward.
7. Pivot the deck back to the driving position and extend the deck catch pin to lock it. Verify the catch engages the hole in the pivoting deck.



WARNING

An unlocked pivoting deck can result in loss of cargo or loss of control of the trailer, which can result in death or serious injury.

Before towing the trailer:

- Lock the pivoting deck in the driving position.
- Verify that the catch engages the hole in the pivoting deck.

5.2.2 Unload Hydraulic Tilt Trailer

1. Couple the trailer to the tow vehicle.



WARNING

Trailer must be coupled to tow vehicle before unloading trailer.

2. Park the tow vehicle and trailer on a firm, level surface.
3. Clear the area around the trailer.
4. Remove chains, straps, and tensioning devices.
5. Read and understand the hoist operating procedure before operating the tilt deck.
- 6.. Locate the tilt deck controller. Position yourself in a safe location, clear of the tilt deck.
7. Press and hold the button to raise the tilt deck. Release the button when the rear of the tilt deck touches the ground.
8. Unload the cargo from the trailer.
9. Press and hold the button to lower the tilt deck. Release the button when the tilt deck is in the driving position.
10. Stow the controller.

5.3 Hydraulic Components

- **Do not alter or substitute** any hydraulic components on the trailer.
- The hydraulic system is designed with specific components to ensure safe and reliable operation.
- **Never alter the hydraulic pressure** or flow rate in the system.

 DANGER
<p>Crushing hazard.</p> <p>An altered or component substituted hydraulic system may malfunction, resulting in the tilt deck falling without warning.</p> <p>NEVER alter or substitute any hydraulic system component.</p>

- Always have the hydraulic system **repaired or maintained** by a qualified technician.

5.4 Securing Cargo

 WARNING
<p>Shifting cargo can result in loss of control of the trailer, and can lead to death or serious injury.</p> <p>Tie down all loads with proper sized fasteners, chains, straps, etc.</p>

Refer to www.fmcsa.dot.gov for regulations regarding cargo securement rules.

6. Pre-Tow Checklist

6.1 Pre-Tow Checklist

Before towing, ensure the following:

- **Tires, wheels, and lug nuts:** Refer to the "Breaking In A New Trailer" section of the manual.
- **Tire pressure:** Inflate tires on both the trailer and tow vehicle to the pressure stated on the Certification/VIN label.
- **Coupler secured and locked:** Check the "Coupling To Tow Vehicle" section of the manual.
- **Safety chains:** Ensure they are properly rigged to the tow vehicle (not to the hitch or ball). See the "Coupling To Tow Vehicle" section.
- **Lights:** Test tail, stop, and turn lights.
- **Trailer brakes:** Test them for proper function.
- **Safety breakaway lanyard:** Ensure it's fastened to the tow vehicle, not to the safety chains. Check the "Coupling To Tow Vehicle" section.
- **Cargo:** Confirm the load is properly loaded, balanced, and tied down. See the "Loading and Unloading" section.
- **Tongue weight and weight distribution:** Verify setup.
- **Ramps:** Ensure they are secured for travel.
- **Fire extinguisher:** Ensure it is available.
- **Flares and reflectors:** Have them ready for use.

6.2 Routine Towing Checks

After every 50 miles or one hour of towing, stop and check the following:

- **Coupler:** Ensure it is secured.
- **Safety chains:** Confirm they are fastened and not dragging.
- **Cargo:** Verify the load is still secured.

7. Breaking in a New Trailer

7.1 Retighten Lugs at Mile Markers 10, 25 & 50

After the initial assembly of a new trailer, the wheel lugs can shift and settle, requiring inspection. It is crucial to check and retighten the lug nuts at 10, 25, and 50 miles of towing. Failing to do so could cause a wheel to come loose, resulting in a serious accident or fatality.

Improperly tightened lug nuts or bolts can also void the axle warranty.

For detailed instructions, refer to the **Inspection, Service, and Maintenance** section of this manual.

 WARNING	
Lug nuts or bolts are prone to loosen after being first assembled. Death or serious injury can result.	
Check lug nuts or bolts for tightness on a new trailer, and after re-mounting a wheel at 10, 25 and 50 miles.	

7.2 Adjust Brakes at First 200 Miles

Brake shoes and drums wear quickly during the initial use and should be adjusted after the first 200 miles, then every 3,000 miles thereafter. Some axles have an automatic brake adjustment feature.

Check your axle and brake manual to confirm if your brakes are self-adjusting. If you don't have the manual, contact your dealer for help.

If your trailer is not equipped with self-adjusting

brakes, manual adjustment will be necessary. See Section 9 for instructions on how to adjust the brakes.

7.3 Trailer Brake Synchronization

Trailer brakes are engineered to operate in harmony with the tow vehicle's braking system. When properly synchronized, both systems work together to slow down the vehicle and trailer smoothly, preventing the trailer tongue from diving or rising abruptly during braking.

 WARNING	
If trailer and tow vehicle brakes do not work properly together, death or serious injury can occur.	
Road test the brakes in a safe area at no more than 30 m.p.h. before each tow.	

To maintain safe brake performance and proper synchronization, carefully read and follow the instructions provided by the axle, brake, and brake controller manufacturers. If these instructions are unavailable, consult your dealer for assistance.

8. Accessories

This chapter provides essential guidelines for the safe use of trailer accessories. Ensure you thoroughly review and follow these instructions before operating any accessory. If you are unsure or lack specific instructions, contact your dealer for clarification prior to use.

8.1 Accessory Battery

Your trailer includes an accessory battery designed to power the dump body.

- **Charging Options:** The battery can be charged through the tow vehicle, an auxiliary charger, or an onboard battery maintainer/charger (if equipped). For trailers used daily, it is recommended to plug in the charger after each day's use.
- **Battery Location:** The accessory battery is housed either in a tongue-mounted or side-mounted battery box.
- **Storage Maintenance:** Always keep the battery fully charged during storage to prevent it from freezing and breaking.
- **Hydraulic System Dependency:** A fully charged battery is essential for maintaining hydraulic pump pressure. A partially charged battery may result in fluid flowing back into the hydraulic reservoir, potentially overfilling it and causing hydraulic fluid to spill into the battery box.

Regular maintenance and proper handling of the accessory battery are crucial for reliable trailer operation and preventing damage.

 WARNING
Risk of battery exploding.
Battery box prop rod may contact battery terminals, which may result in the battery exploding.
Place battery box lid prop rod in retaining clip.

9. Inspection, Service & Maintenance

9.1 Inspection, Service and Maintenance Summary Charts

Regular inspection, maintenance, and servicing of your trailer are essential to ensure safe and reliable operation. If you are unable to perform these tasks or are uncertain about how to proceed, consult your dealer for assistance.

Note: In addition to following this manual, review the relevant component manufacturer's manual for specific guidance.

Inspection And Service Before Each Tow		
Item	Inspection/Service	Manual Section Reference
Breakaway Brakes • Electric • Hydraulic	Check Operation Check Operation	Section 4 Section 4
Breakaway Battery	Fully charged, connections clean	Section 4 and 9
Brakes • Electric • Surge	Check Operation Check Operation Check Master Cylinder Level	Section 4 and 9
Shoes and Drums	Adjust	Section 9
Safety Chains and Hooks	Check for wear, damage	Section 4
Coupler and Hitch Ball	Check for cracks, pits, and flats. Replace with ball and coupler having trailer GVW Rating. Grease. Check locking device and replace when worn.	Section 4 and 9 Section 4 and 9 Section 4 and 9
Ring and Pintle	Check for cracks, pits, and flats. Replace with ring and pintle having trailer GVW Rating. Grease. Check locking device & replace when worn.	Section 4 and 9 Section 4 and 9 Section 4 and 9

Tires	Check tire pressure when cold. Inflate as needed.	Section 6 and 9
	Check for damage.	Section 6 and 9
Wheels - Lug Nuts or Bolts and Hub	Check for tightness.	Section 6
	Tighten. For new and remounted wheels, check torque after first 10, 25 and 50 miles of driving and after any impact.	Section 7 and 9

Inspection and Service Every Month

Item	Inspection/Service	Manual Section Reference
Lubrication	Lubricate tilt deck pivot points (if equipped)	Section 9
	Lubricate hydraulic cylinder ends (if equipped)	Section 9

Inspection and Service Every 6 Months or 6,000 Miles

Item	Inspection/Service	Manual Section Reference
Brakes, electric		
• Magnet	Check wear and current draw.	Section 9
• Controller (in tow vehicle)	Check power output (amperage) and modulation.	Section 9 See Controller Manufacturer's Manual

<p>Tires</p>	<p>Inspect tread and sidewalls thoroughly.</p> <p>Replace tire when treads are worn, when sidewall has a bulge, or sidewall is worn.</p> <p>Rotate every 5,000 Miles.</p>	<p>Section 9</p> <p>Section 9</p> <p>Section 9</p>
<p>Brakes</p> <ul style="list-style-type: none"> • Electric • Surge 	<p>Check Operation</p> <p>Check Operation</p> <p>Check Master Cylinder Level</p>	<p>Section 4</p>
<p>Brake Shoes and Drums</p>	<p>Adjust</p>	<p>Section 7 and 9</p>
<p>Safety Chains and Hooks</p>	<p>Check for wear, damage</p>	<p>Section 4</p>
<p>Coupler and Hitch Ball</p>	<p>Check for cracks, pits and flats. Replace with ball and coupler having trailer GVW Rating.</p> <p>Grease.</p> <p>Check locking device and replace when worn.</p>	<p>Section 4</p> <p>Section 4 and 9</p> <p>Section 4 and 9</p>

Ring and Pintle	Check for cracks, pits, and flats. Replace w/ ring and pintle having trailer GVW Rating.	Section 4
	Grease.	Section 4 and 9
	Check locking device & replace when worn.	Section 4 and 9

Inspection and Service Every Year or 12,000 Miles

Item	Inspection/Service	Manual Section Reference
Brakes, all types • Shoes and Drums	Check for scoring and wear. Replace per manufacturer's specifications.	Section 9 See Brake Manufacturer's Manual
Jack, Drop-leg (if equipped)	Grease gears at top	See Jack Manufacturer's Manual
Structure • Frame Members	Inspect all frame members, bolts and rivets. Repair or replace damaged, worn or broken parts.	Section 9
• Welds	Inspect all welds. Repair as needed.	Section 9
Wheels • Wheel Bearings	Disassemble/Inspect/assemble and repack. Replace promptly if immersed in water.	Section 9 See Axle Manufacturer's Manual
• Rims	Inspect for cracks and dents. Replace as needed.	

Structure • Axle Attachment Bolts	Check by dealer	Section 9
---	-----------------	-----------

9.2 Inspection and Service Instructions

 WARNING

Worn or broken suspension parts can cause loss of control and injury may result.

Have trailer professionally inspected annually and after any impact.

To carry out many inspection and maintenance tasks, you will need to jack up the trailer.

Important Guidelines:

- Position jacks and jack stands carefully to avoid damaging wiring, brake lines, and suspension components such as springs or torsion bars.
- Always place jacks and jack stands under the outer frame rail where the axles are mounted for safe and stable support.

 WARNING

Never go under trailer unless it is on firm and level ground and resting on properly placed and secured jack stands.

 WARNING

Crushing hazard.

The tow vehicle and trailer could be inadvertently moved while a person is under the trailer.

The tow vehicle engine must be off, ignition key removed and parking brakes set before entering the area under the trailer.

9.2.1 Washing Your Trailer is Important Too

Maintain your trailer's appearance and longevity by cleaning it regularly with a power washer and a quality detergent solution. Proper washing helps remove dirt, debris, and grime that can accumulate over time, preventing corrosion and keeping the trailer in excellent condition for reliable performance.

9.2.1.1 Fasteners and Frame Members

Thoroughly inspect all fasteners and structural frame components for signs of bending, damage, cracks, or failure. Address any issues promptly by repairing or replacing damaged fasteners and ensuring the frame is properly restored. If you're uncertain about the condition of a component or the best method for repair, consult your dealer for expert recommendations or have them handle the repairs for you.

 WARNING
Broken or damaged fasteners can cause injury or damage to trailer and contents.
Inspect for, and repair all damaged parts at least once a year.

9.2.1.2 Welds

Welds can crack or fail under heavy loads or when cargo shifts unexpectedly due to improper securing. If the trailer has been subjected to such conditions, immediately inspect all welds and fasteners for signs of damage. To avoid significant trailer damage, perform a thorough inspection of all welds at least once a year. If you discover any weld failures, promptly contact your dealer for professional assessment and repair.



WARNING

Do not attempt to repair a cracked or broken weld unless you have the skills and equipment to make the repair.

Improper weld repair will lead to early failure of the trailer structure and serious injury or death.

See your dealer for weld repairs.



WARNING

Broken or damaged welds can cause injury or damage to trailer and contents.

Inspect for, and repair all damaged parts at least once a year.

9.2.2 Electric Trailer Brakes

9.2.2.1 Brake Discs, Shoes and Drums

Properly functioning brake shoes and drums are vital for ensuring safe trailer operation. To maintain safety, have your dealer inspect these components at least once per year or every 12,000 miles. Note that brake adjustment is not covered under the axle warranty.

- **Brake Adjustment Schedule:** Adjust the brake shoes after the first 200 miles of use and then every 3,000 miles.
- **Automatic Brake Adjustments:** Many axles feature a mechanism that adjusts the brake shoes automatically during a "hard brake" from a rearward direction. Trailer disc brakes are self-adjusting and do not require periodic adjustments.

- **Importance of Brake Lining Material:** Operating with worn pads or shoes can lead to brake damage, excessive heat, and potential loss of braking capacity.

Refer to your axle and brake manual for specific instructions on brake adjustments. If you lack the manual, contact your dealer for assistance.

9.2.2.2 Manually Adjusting Brake Shoes

Some braking systems require manual adjustments as they are not automatically adjusted. Follow these steps to adjust manually adjustable brakes:

1. **Secure the Trailer:** Jack up the trailer and ensure it is supported securely on jack stands with adequate capacity.

2. **Check Wheel Rotation:** Confirm that the wheel and brake drum rotate freely.

3. **Access the Adjuster:** Remove the adjusting-hole cover from the slot at the bottom of the brake backing plate.

4. **Expand Brake Shoes:** Using a screwdriver or brake adjustment tool, rotate the starwheel of the adjuster assembly to expand the brake shoes. Adjust until the brake linings press against the drum, making the wheel difficult to turn.

- **Note:** For trailers equipped with drop spindle axles, refer to your axle manual for specific adjustments. A modified adjustment tool may be required.

5. **Fine-Tune Adjustment:** Rotate the starwheel in the opposite direction until the wheel spins freely with only

a slight drag.

6. **Replace Cover:** Reinstall the adjusting-hole cover.

7. **Repeat Process:** Perform the same adjustment procedure for all brakes on the trailer.

8. **Lower the Trailer:** Once all adjustments are complete, lower the trailer back to the ground.

For detailed guidance, consult your axle and brake manual. If unavailable, contact your dealer for assistance.

9.2.2.3 Types of Electric Brakes

1. **Emergency Electric Breakaway System:**

This system engages only if the trailer detaches from the tow vehicle, pulling the breakaway pin. It is designed to automatically activate the trailer brakes in such an emergency.

2. **Standard Electric Braking System:**

This system works in conjunction with the tow vehicle's brakes, applying braking force to the trailer whenever the tow vehicle brakes are activated.

Breakaway Battery

The breakaway battery powers the trailer brakes in the event of uncoupling from the tow vehicle. To ensure proper functionality:

- Regularly inspect, maintain, and replace the battery according to the manufacturer's guidelines.
- Note that your trailer may use the hydraulic system battery to operate the breakaway brakes.

Proper care and understanding of these systems are essential for safe towing and braking operations.

 CAUTION
<p>Extreme cold weather can degrade battery performance and cause brakes to not operate properly.</p> <p>Check battery charge level before towing.</p>

Breakaway Switch

The breakaway switch is a critical safety feature that activates the electric brakes if the trailer detaches from the tow vehicle.

How to Test the Breakaway System:

- 1. Pull the Pin:** Remove the pin from the breakaway switch.
- 2. Check Brake Engagement:** Confirm the brakes are engaging by attempting to pull the trailer with the tow vehicle.
 - The trailer brakes may not fully lock, but you should feel significant resistance.

Regularly testing the breakaway switch ensures the system functions properly in an emergency, providing an added layer of safety during towing.

 WARNING
<p>If electric breakaway brakes do not operate when trailer is uncoupled from the tow vehicle, death or serious injury can occur.</p> <p>Check emergency breakaway brake system before each tow.</p>

9.2.2.4 Tow Vehicle Operated Electric Brakes

The **electric brakes** on the trailer that function in tandem with the tow vehicle's brakes must be properly **synchronized** to ensure safe and effective braking. This ensures the brakes on both the trailer and the tow vehicle engage proportionally.

For Correct Operation:

- Always **read and follow** the instructions provided by the manufacturers of the axle, brake system, and brake controller.
- If these instructions are unavailable, contact your dealer for further assistance.

Ensuring proper synchronization between the tow vehicle's brakes and the trailer's electric brakes is crucial for smooth and balanced braking performance.

9.2.2.5 Electric Brake Magnets

To ensure the proper functioning of the electric braking system, have your dealer inspect the magnets at least once a year or every 12,000 miles. Refer to the brake manual for specific wear and inspection guidelines.

9.2.3 Trailer Brakes - Surge (If Equipped)

9.2.3.1 Surge Brake Master Cylinder

Before towing, always inspect the fluid level in the surge brake master cylinder, typically located on the trailer tongue. The fluid level should reach the "full" mark on the reservoir.

For the correct brake fluid type required for the system, consult your dealer or refer to the trailer's specifications.

9.2.3.2 Hydraulic Surge Brake

Before towing, complete the following inspection and maintenance steps:

1. **Brake Fluid Check:** Ensure the master cylinder fluid level is full as described previously. Inspect for leaks and address any needed repairs.
2. **Actuator Inspection:** Examine the actuator for signs of wear, bent parts, corrosion, or damage. Replace any affected components with genuine service parts.
3. **Mounting Bolts:** Verify that the actuator mounting bolts are securely tightened to the manufacturer's specifications.
4. **Brake and Actuator Testing:** Test the actuator and brake function as outlined in the Coupling to Tow Vehicle section. Actuator travel exceeding one inch may indicate a need for brake adjustment or structural damage. Follow the brake installation manual for proper adjustment.
5. **Lubrication:** Before storage or after prolonged use, apply motor oil to the coupler components and internal rollers to ensure smooth movement and prevent rust.
6. **Additional Maintenance:** Refer to the surge brake manufacturer's manual for other required inspection and maintenance procedures. Contact your dealer if the manual is unavailable.

Proper inspection and maintenance are essential for safe and effective braking performance.

9.2.3.3 Master Cylinder Bleeding

Follow these steps to properly bleed the trailer brake master cylinder:

1. Prepare the System:

- Remove the master cylinder cap and fill the reservoir to three-quarters full with DOT-3 or DOT-4 brake fluid.
- Avoid contact between brake fluid and painted surfaces to prevent damage. Clean up spills immediately and rinse with water.

2. Choose Bleeding Method:

- Use a pressure bleeder for simplicity (available at automotive supply stores) and follow its instructions.
- For manual bleeding, enlist an assistant and follow the steps below:

Manual Bleeding Steps:

Trailer Setup:

- Disconnect the trailer from the tow vehicle and jack up the tongue to a horizontal position. Ensure wheels are securely blocked to prevent movement.

Fill the Master Cylinder:

- Top up the master cylinder with the correct brake fluid.

Attach Bleeder Hose:

- Connect a bleeder hose to the bleeder screw on the wheel cylinder farthest from the actuator. Submerge the other end of the hose in a container of brake fluid to monitor air bubbles.

Bleed the System:

- Open the bleeder screw, and have the assistant stroke the actuator without releasing it.
- Observe the fluid and bubbles flowing into the container. Close the bleeder screw before the actuator returns to its resting position.
- Repeat until no air bubbles are visible, ensuring to secure the bleeder screw.

Repeat for All Wheels:

- Perform this process for each wheel cylinder, starting with the rear axle if multiple axles are present.

3. Maintain Fluid Levels:

- During bleeding, frequently replenish the master cylinder reservoir with fresh brake fluid to avoid introducing air into the system.

4. Final Steps:

- After completing bleeding at all wheels, refill the master cylinder to the appropriate level and securely reinstall the filler cap.

Proper bleeding ensures optimal braking efficiency by removing trapped air from the system.



WARNING

Use only fresh fluid from a sealed container. DO NOT reuse fluid. After filling and bleeding, refill the actuator.

Failure to maintain an adequate fluid level may cause brake failure.

9.2.2.4 Tow Vehicle Operated Electric Brakes

The **electric brakes** on the trailer that function in tandem with the tow vehicle's brakes must be properly **synchronized** to ensure safe and effective braking. This ensures the brakes on both the trailer and the tow vehicle engage proportionally.

For Correct Operation:

- Always **read and follow** the instructions provided by the manufacturers of the axle, brake system, and brake controller.
- If these instructions are unavailable, contact your dealer for further assistance.

Ensuring proper synchronization between the tow vehicle's brakes and the trailer's electric brakes is crucial for smooth and balanced braking performance.

9.2.2.5 Electric Brake Magnets

To ensure the proper functioning of the electric braking system, have your dealer inspect the magnets at least once a year or every 12,000 miles. Refer to the brake manual for specific wear and inspection guidelines.

9.2.3 Trailer Brakes - Surge (If Equipped)

9.2.3.1 Surge Brake Master Cylinder

Before towing, always inspect the fluid level in the surge brake master cylinder, typically located on the trailer tongue. The fluid level should reach the "full" mark on the reservoir.

For the correct brake fluid type required for the system, consult your dealer or refer to the trailer's specifications.

9.2.3.2 Hydraulic Surge Brake

Before towing, complete the following inspection and maintenance steps:

1. **Brake Fluid Check:** Ensure the master cylinder fluid level is full as described previously. Inspect for leaks and address any needed repairs.
2. **Actuator Inspection:** Examine the actuator for signs of wear, bent parts, corrosion, or damage. Replace any affected components with genuine service parts.
3. **Mounting Bolts:** Verify that the actuator mounting bolts are securely tightened to the manufacturer's specifications.
4. **Brake and Actuator Testing:** Test the actuator and brake function as outlined in the Coupling to Tow Vehicle section. Actuator travel exceeding one inch may indicate a need for brake adjustment or structural damage. Follow the brake installation manual for proper adjustment.
5. **Lubrication:** Before storage or after prolonged use, apply motor oil to the coupler components and internal rollers to ensure smooth movement and prevent rust.
6. **Additional Maintenance:** Refer to the surge brake manufacturer's manual for other required inspection and maintenance procedures. Contact your dealer if the manual is unavailable.

Proper inspection and maintenance are essential for safe and effective braking performance.

9.2.3.3 Master Cylinder Bleeding

Follow these steps to properly bleed the trailer brake master cylinder:

1. Prepare the System:

- Remove the master cylinder cap and fill the reservoir to three-quarters full with DOT-3 or DOT-4 brake fluid.
- Avoid contact between brake fluid and painted surfaces to prevent damage. Clean up spills immediately and rinse with water.

2. Choose Bleeding Method:

- Use a pressure bleeder for simplicity (available at automotive supply stores) and follow its instructions.
- For manual bleeding, enlist an assistant and follow the steps below:

Manual Bleeding Steps:

Trailer Setup:

- Disconnect the trailer from the tow vehicle and jack up the tongue to a horizontal position. Ensure wheels are securely blocked to prevent movement.

Fill the Master Cylinder:

- Top up the master cylinder with the correct brake fluid.

Attach Bleeder Hose:

- Connect a bleeder hose to the bleeder screw on the wheel cylinder farthest from the actuator. Submerge the other end of the hose in a container of brake fluid to monitor air bubbles.

Bleed the System:

- Open the bleeder screw, and have the assistant stroke the actuator without releasing it.
- Observe the fluid and bubbles flowing into the container. Close the bleeder screw before the actuator returns to its resting position.
- Repeat until no air bubbles are visible, ensuring to secure the bleeder screw.

Repeat for All Wheels:

- Perform this process for each wheel cylinder, starting with the rear axle if multiple axles are present.

3. Maintain Fluid Levels:

- During bleeding, frequently replenish the master cylinder reservoir with fresh brake fluid to avoid introducing air into the system.

4. Final Steps:

- After completing bleeding at all wheels, refill the master cylinder to the appropriate level and securely reinstall the filler cap.

Proper bleeding ensures optimal braking efficiency by removing trapped air from the system.



WARNING

Use only fresh fluid from a sealed container. DO NOT reuse fluid. After filling and bleeding, refill the actuator.

Failure to maintain an adequate fluid level may cause brake failure.

9.2.4 Trailer Connection to Tow Vehicle

9.2.4.1 Coupler and Ball

Follow these steps to ensure the coupler and ball are in proper working condition before each tow:

1. Grease the Ball:

- Apply a thin layer of automotive bearing grease to the ball to reduce wear and facilitate smooth operation.

2. Inspect the Coupler and Ball:

- Check the locking device to confirm it securely fastens the coupler to the ball.
- Examine the ball and coupler for signs of wear, such as flat spots, deformations, pitting, or corrosion.

3. Replace Damaged Parts:

- If you detect damage or wear, consult your dealer for inspection and necessary replacement of the ball or coupler system.
- Replace any bent or broken coupler components before towing.

4. Maintain the Coupler Mechanism:

- Ensure the coupler latch lever rotates freely and automatically snaps into place.
- Lubricate pivot points, sliding surfaces, and spring ends with SAE 30W motor oil.
- Clean the ball pocket and latch mechanism regularly to remove dirt or contaminants that may hinder proper function.

5. Match Ball Load Rating to Trailer:

- When replacing the ball, ensure its load rating meets or exceeds the trailer's *GVWR*.

Adhering to these maintenance practices ensures the safety and reliability of the ball and coupler system during towing.

9.2.4.2 Ring and Pintle

Follow these steps to maintain the ring and pintle system for safe towing:

1. Apply Grease to the Ring:

- Coat the ring with a thin layer of automotive bearing grease to minimize wear and ensure smooth operation.

2. Inspect the Ring and Pintle:

- Examine the locking device to confirm it secures the pintle to the ring effectively.
- Check the ring and pintle for signs of wear, including flat spots, deformations, pitting, or corrosion.

3. Replace Damaged Components:

- If wear or damage is detected, consult your dealer for inspection and appropriate replacements.
- Replace any bent or broken parts before towing.

4. Maintain the Pintle Mechanism:

- Ensure the pintle handle lever rotates freely and locks automatically into place.
- Lubricate pivot points, sliding surfaces, and spring ends with SAE 30W motor oil.
- Clean the ring pocket and latch mechanism to remove dirt or contaminants that may impede operation.

5. Ensure Load Rating Matches:

- When replacing the ring, verify that its load rating meets or exceeds the trailer's GVWR.

Proper maintenance of the ring and pintle system ensures reliable and secure towing operations.

9.2.5 Landing Leg or Jack

If a grease fitting is present, use a grease gun to lubricate the jack mechanism. For hand-cranked jacks, grease the gears at the top once a year by removing the top of the jack and either pumping or manually packing grease into the gears.

9.2.6 Lights and Signals

Prior to each tow, ensure all trailer lights are functioning correctly.



9.2.7 Wheel Rims

If the trailer has been hit or impacted near the wheels, or has struck a curb, examine the rims for any damage. Replace any wheels that are damaged. Additionally, inspect the wheels annually, even if no noticeable impacts have occurred.

9.2.8 Wheel Bearings

A loose, worn, or damaged wheel bearing is a common cause of brakes that grab. To inspect the bearings, jack up the trailer and secure it with appropriate jack

stands. Check for any side-to-side movement in the wheels. If the wheels are loose or wobble as they spin, the bearings need to be serviced or replaced.



WARNING

Never go under trailer unless it is on firm and level ground and resting on properly placed and secured jack stands.

If your axle(s) have a grease zerker at the ends, the bearings should be greased every 6 months or 6,000 miles to maintain safe and reliable trailer operation.

1. Remove the rubber plug from the axle end.
2. Attach the grease gun to the zerker fitting.
3. Pump grease until fresh grease starts to appear. Use a different color of grease each time so you can clearly see when the new grease has begun to flow.
4. Replace the rubber plug and cap. Repeat the process for all wheel bearings.

If your axle(s) don't have grease zerkers, refer to the axle manufacturer's manual for proper service and maintenance instructions.



9.2.9 Tires

Before towing, always check the tire pressure to ensure it matches the level indicated on the tire sidewall or VIN label. Tire pressure should be checked when the tires are cold—avoid checking immediately after towing. Allow at least three hours for the tires to cool if the trailer has been driven.

Tires naturally lose air over time. Replace any tire that has less than 2/32 inch of tread depth or shows visible wear indicators. Inspect both sidewalls for any bubbles,

cuts, or bulges, and replace any tires with such damage before towing.

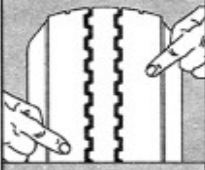
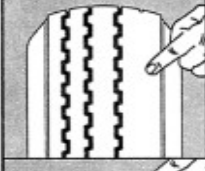
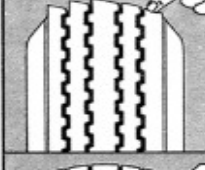
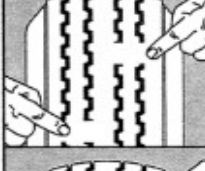
If you're storing the trailer for an extended period, inflate the tires to the maximum recommended pressure on the sidewall or VIN label. Store the trailer in a cool, dry environment, such as a garage, and use tire covers to protect the tires from sun damage.

	Condition	Possible Cause	Remedy
	Even Center Wear	Over Inflation	Check & Adjust Pressure When Cold
	Inside & Outside Wear	Under Inflation	Check & Adjust Pressure When Cold
	Smooth, Side Wear - One Side	Loss of Camber or Overloading	Check & Unload As Necessary Have Alignment Checked
	"Feathering" Across The Face	Axle Not Square To Frame or Incorrect Toe In	Square Axles Have Alignment Checked
	Cupping	Loose Bearings or Wheel Balance	Check Bearing Adjustment and Wheel & Tire Balance
	Flat Spots	Wheel Lockup	Adjust Brakes

Tire Inspection Chart



WARNING

Worn, damaged or under-inflated tires can cause loss of control, injury and damage.

Check tires before each tow.

9.2.10 Lubrication

Lubricate tilt deck pivots and hydraulic cylinder ends every month (if equipped).

9.2.11 Hydraulic Reservoir

Check the fluid level before towing the trailer. The reservoir is typically located inside the battery box. Ensure the tilt deck is fully lowered before checking the fluid. The reservoir should be filled to the full mark on the side. Use high-quality hydraulic fluid with anti-wear properties, rust, and oxidation inhibitors. If fluid is ejected from the reservoir, it may indicate a low battery.

9.2.12 Lug Nuts or Bolts

Lug nuts can loosen after a wheel is mounted to a hub. To ensure safety, check the tightness of the lug nuts after the first 10, 25, and 50 miles of driving, as well as before each subsequent tow.



WARNING

Lug nuts or bolts are prone to loosen after being first assembled. Death or serious injury can result.

Check lug nuts or bolts for tightness on a new trailer, and after re-mounting a wheel at 10, 25 and 50 miles.



WARNING

Metal creep between the wheel rim and lug nuts or bolts can cause rim to loosen.

Death or injury can occur if wheel comes off.

Tighten lug nuts or bolts before each tow.

To prevent the wheels from coming loose, tighten the lug nuts or bolts in three stages to the specified final torque for your trailer's axle size. Follow the correct order shown in the figure below.

Always use a calibrated torque wrench to ensure proper tightening. Make sure the wheel studs are free of contaminants, such as paint or grease, to ensure accurate torque readings. Over-tightening can cause the studs to break or the mounting stud holes in the wheels to deform, which will void the axle warranty.

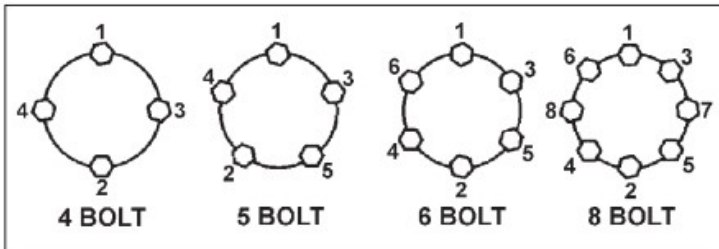

Refer to your axle manufacturer's manual or consult your dealer for the specific wheel nut or bolt torque specifications.

10. Warranty Policy

All transactions between you, the dealer ("Dealer") and Gorilla Trailers LLC. ("Gorilla Trailers LLC") are subject to the following General Terms and Conditions:

1. Gorilla Trailers warrants the Covered Product to be free of all defects in material and workmanship for 6 months from the date of purchase. This warranty extends to the original buyer only.

2. Within the period of this warranty, Gorilla Trailers will repair, free of charge; any part proving defective in material or workmanship. All warranty repairs and service must be performed by an authorized Gorilla Trailers technician, or at an authorized Gorilla Trailers service facility.

3. Warranty work is determined by the dealer and or Gorilla Trailers LLC upon inspection of the Trailer. It is Gorilla Trailer LLC. sole discretion to determine whether the warranty is a valid warranty or not a valid warranty.

4. Buyer is responsible for transportation cost to the facility where they purchased the product from for warranty work to be performed. Gorilla Trailer does not allow warranty work to be determined or performed by any company other than the company the buyer purchased the product from.

5. Not Covered or paid by Gorilla Trailer LLC:

Damages caused by the use of the product. Damages to property or persons caused by the use of the product. Damages to any product being hauled on or inside of the trailer. Physical damage to persons or property from the use of the trailer. Transportation costs to the location

where the buyer purchased the product for warranty work to be performed. Customer agrees to indemnify Gorilla Trailers LLC and save and hold Gorilla Trailers LLC harmless and free from liability against any and all claims, damages, or assertion of liability of every nature whatsoever to person or property arising out of, or in connection with, the handling or use of all such products as Gorilla Trailers LLC may cause to be delivered to Customer, including, but not limited to any and all claims based on asserted defects of material or the workmanship of such products. You agree to indemnify, hold harmless, release and discharge Gorilla Trailers LLC and employee's from any and all damages, claims of injury resulting from the negligence of Gorilla Trailers LLC. Customer agrees to assume all risk incident to the care, handling, and use of all products purchased; and warrants, by the purchase of an item, that Customer is familiar with the item and its proper use. Before using an item, the Customer shall give such item reasonable and prudent examination and/or tests to determine the suitability of the item for the Customer's intended use. Customer agrees that the product is in full working order and is taking delivery of the product without defect. The customer agrees that in order to have warranty work performed Customer must bring the product back to the physical location of the dealership where the item was purchased regardless of whether the item was delivered to the customer.

6. Warranty Exclusions: This warranty does not apply to any costs, repairs, or services for the following:

a. Service calls to correct the installation of the Covered Product, or to explain the usage of the product to the buyer.

- b. Repairs necessitated by use other than normal home use.
- c. Damage resulting from misuse, abuse, accidents, alterations, or improper installation.
- d. Corrective work necessitated by repairs made by any one other than a Gorilla Trailers authorized service technician.
- e. Component warranties in Section 10 below.

7. How to Obtain Warranty Service:

- a. Contact Dealer or Retailer where you purchased, if you are having trouble contacting Dealer or Retailer where purchased please contact Gorilla Trailers LLC. at 615-215-4285.
- b. Send photos to determine whether the defect in the product is covered by the warranty.
- c. If a defect in the product is covered by warranty make an appointment with said Dealer or Retailer to be Repaired at the Dealer location or at Gorilla Trailer LLC facility.

8. Registration cards are located at the bottom of every Gorilla Trailer Title / MSO. All buyers must complete and send in a registration card within 7 days of purchase in order for any product to have an active warranty. If the Buyer does not send in a Registration Card within a 7-day time frame warranty will be void.

Please email all Cards at bottom of MSO/TITLE to
Sales@gorillatrailer.com

9. Keep up to date with the trailer maintenance to ensure proper use and to prevent damage. Below is a list of items to check to ensure the trailer operates safely and prevent damage after every use. The trailer needs to be inspected at least once every six months by an

authorized weld shop or by an authorized trailer dealer to ensure the trailer is fit for road use.

a. Check welds on the trailer after every load that is over 1000 lbs of cargo weight. Trailers are constantly moving on the road and flexing the metal can, depending on the load, become fatigued over time or if you hit road obstacles like potholes. After using the trailer to haul cargo weight of over 1000 lbs you need to inspect key welded areas. These include but are not limited to where axles are bolted to the trailer. There is a weld that binds the trailer to the frame of the trailer; here you want to ensure that welds are fully welded on both sides of these u-shaped hangers and that the welds are welded 360 degrees all the way around these hangers. A couple of welds are located where the ball connects to the trailer. The coupler is welded to the frame and both welds on either side of the couple should go the full length of the coupler (about 9 inches) attached to the frame of the trailer. Trailer tongue welds are located on the frame that is attached to the coupler which is attached to the ball; here the frame welds should be located wherever the frame rails touch cross-sections of the trailer frame. Gate welds are located on the tailgate of the trailer; here they are what attaches the gate to the trailer. If any weld is not located in these areas, stop use of the trailer immediately. Also, if there is not a weld of at least one inch in length in any of these areas, stop use immediately. If the weld has a crack in any of these areas, stop use immediately. If any weld is separating from the two pieces of metal it is connecting, stop use immediately. If you have any questions about the construction of your trailer, please contact us at 615-215-4285.

b. Check all bolts and nuts on the trailer. Every trailer is different but all bolts and nuts should be tight, not

loose. For exact specifications of how tight the bolts should be please call us at 615-215-4285. Some key areas to inspect bolts and nuts are chains located on the coupler where the ball connects to the vehicle. Axles are bolted to the trailer behind the tires. There are at least 3 bolts on either side of the trailer but some trailers have up to 6 on either side of the trailer for a total of 12 bolts and nuts. They should be snug up to the steel, the bolt head should be tight to the steel and the nut on the other side should be tight to steel like a sandwich. Another area to inspect is the lug nuts which should be tight on the wheels. You need to inspect lug nuts on the wheels after every use. All lug nuts should be on the wheels and should be tight. Please call Dexter Axles at 260-636-5311 for exact specifications of how tight your lug nuts should be on your wheels. Jacks are also bolted to the trailer frame and need to be periodically checked to ensure they are tight. Another area that has bolts is where the gate is bolted to the trailer. These bolts have lock nuts. The nuts should be tight on the bolts and ensure that the bolts are going all the way through the nuts. One other area to check on the gate is the spring latch which should always have the spring present so that the rod in the spring latch is held tight through the plate that holds the gate to the trailer. The rod should be at least $\frac{1}{2}$ inch through the plate that is welded to the trailer to ensure the gate does not come loose during transit.

c. Tire inspection please contact Jetstar on how to inspect your tires to ensure they are fit for road use and when you should replace them
<http://jetstartireandwheel.com>

d. Ball coupler latch-Always check your coupler latch to ensure that it is fitting tight to the ball of your vehicle and it is the correct size ball for the coupler you have.

For more instructions on ensuring proper use of your coupler and proper maintenance, contact Pacific Rim International, LLC at 360-859-3828.

10. Gorilla Trailer component warranties listed below:

a. Axles - Most axles are manufactured by Dexter Axle. Here is a link to Dexter Axle warranty information:

<https://www.dexteraxle.com/about-dexter/news/newsitem/2016/08/29/dexter-extends-warranty>.

All warranties related to axles must go through Dexter-Axle or the axle manufacturer. Gorilla Trailers LLC does not warranty axles.

b.

c. Lighting - Most of the lights used on Gorilla Trailers are manufactured by Optronics. All lighting related warranties must go through Optronics

<http://www.optronicsinc.com>.

d.

e. Coupler and Jacks - All coupler and jack warranties must go through Pacific Rim International, LLC. They can be contacted at 360-859-3828. Gorilla Trailers does not manufacture or warranty jacks or couplers.

f. Paint - All paint comes with a 90 - day warranty. If your paint is determined to be defective, you must bring the trailer to Gorilla Trailer LLC to be repainted at no expense to you. Gorilla Trailer LLC will not pay for transportation. Location 264 Hobson St., Smithville, TN 37166. Come from Jetstar. All wheel and tire warranties must go through Jetstar

<http://jetstartireandwheel.com>.

h. SpringLatch - Spring latches are manufactured by Buyers Products: <https://www.buyersproducts.com>. All spring latch warranties on gates must go through Buyers Products.

